

FB-V61A

パーツブック
PARTS BOOK

超々高速安全縫ミシン

ULTRA HIGH SPEED SAFETY STITCH SEWING MACHINE

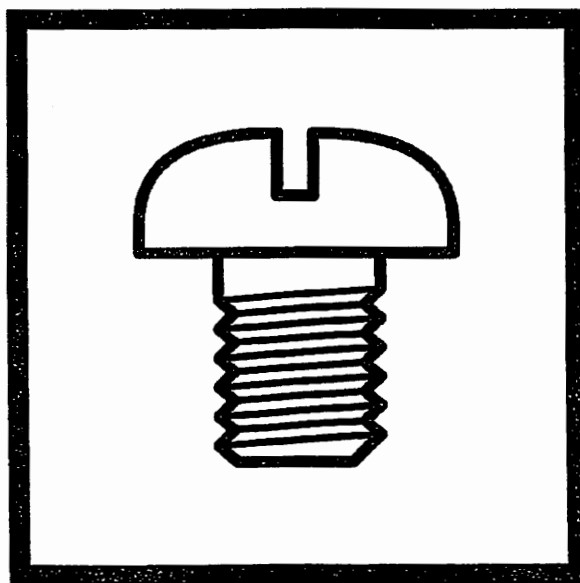

brother.

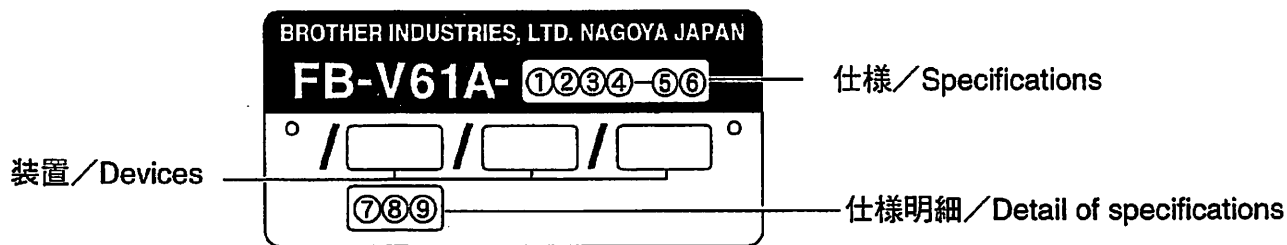

①

縫い目形式 / Stitch form
② 安全縫い・4本糸 / Safety stitch, 4-threads
③ 安全縫い・5本糸 / Safety stitch, 5-threads
④ 安全縫い・6本糸 / Safety stitch, 6-threads

⑥

かがり幅 / Stitch width
② 2 mm
③ 3 mm
④ 4 mm
⑤ 5 mm
⑥ 6 mm
⑦ 7 mm

②

用途 / Applications
① 地縫い / Plain searning
④ ひだ取り / Ruffling
⑤ テープ付け / Taping
⑥ パイピング付ひだ取り / Ruffling with piping
⑦ バインディングテープ付け / Binding with taping

⑦

上ループリフト / Over-looper locus
① スタンダード / Standard lift
② ハイリフト / High lift
③ 超ハイリフト / Extra high lift

③

縫製物 / Sewing materials
① 極薄物～薄物 / Extra light - light materials
② 薄物～中厚物 / Light - medium materials
③ 中厚物～厚物 / Medium - heavy materials
④ 厚物～極厚物 / Heavy - Extra heavy materials
⑤ 極厚物 / Extra heavy materials
⑥ 新素材 / New synthetic fiber

⑧

差動送り量 / 針板チェーンランド / Differential feed deg
② 2列 / チェンランドあり / 2-row / with chain land
③ 3列 / チェンランドあり / 3-row / with chain land

④

特殊用途 / Special use
① 標準 / Standard
② 小回り仕様 / Small type
③ 特殊作動比 / Special differential ratio

⑨

上メス形状 / Upper knife shape
① 平メス / Flat knife
② 角メス / Angle knife
③ 角メス幅広 / Angle knife, wide
④ 角メス波刃 / Angle knife, wave shape
⑤ 角メス幅広波刃 / Angle knife, wave shape

⑤

針幅 / Needle gauge
② 2mm
③ 3mm
④ 5mm
⑤ A 3x2.2mm
⑥ B 5x2.2mm
⑦ C 5x3mm

パーツブックご利用に際して

1. この本は、この本の表紙(正誤表の挿入されている場合は正誤表)に記載されているものと同じプレートが取り付けられているミシンのためのものです。
2. この本は、1998年11月のデータに基づいて作成されたものです。
3. 部品は予告なしに設計変更される場合があります。
4. 組単位で補給する部品は、[] 破線で示しております。
5. 部品コード欄が※となっている場合は、ゲージ部品一覧表(47-53ページ)でお調べ下さい。

目 次

A. 主体関係	1
B. 駆動軸関係	5
C. 針棒関係	7
D. 押工関係	9
E. 送り関係	13
G. 上メス・下メス関係	17
H. 上ルーバ関係	19
J. 下ルーバ関係	21
K. 二重環ルーバ関係	23
L. 給油潤滑関係	25
M. 糸調子関係	27
P. 針冷却関係	31
Q. 縁カガリ定規関係	31
R. ラフラー装置関係	33
T. ラッパー関係	39
Z. 付属品関係	41
Ga. ゲージ部品一覧表	47
Wa. 警告ラベル	54
索引	55

Notes for using this parts book

1. This book is applicable to sewing machines which have the same plate number as shown on the cover of this book (or correction sheet).
2. This book was prepared based on information available in November 1998.
3. Parts are subject to changes in design without prior notice.
4. Parts supplied as complete assemblies are circled by a dotted line [] .
5. If the symbol ※ is found in the "Parts No." column, refer to the different parts list on page 47-53 .

CONTENTS

A. Machine body	1
B. Crankshaft mechanism	5
C. Needle bar mechanism	7
D. Presser foot mechanism	9
E. Feed mechanism	13
G. Knife mechanism	17
H. Over looper mechanism	19
J. Under looper mechanism	21
K. Double chain stitch looper mechanism	23
L. Lubrication	25
M. Thread tension	27
P. Needle cooler	31
Q. Serging attachment	31
R. Ruffling attachment	33
T. Lapper mechanism	39
Z. Accessories	41
Ga. Gauge parts List	47
Wa. Warning labels	54
INDEX	55

A. 主体関係 / Machine body

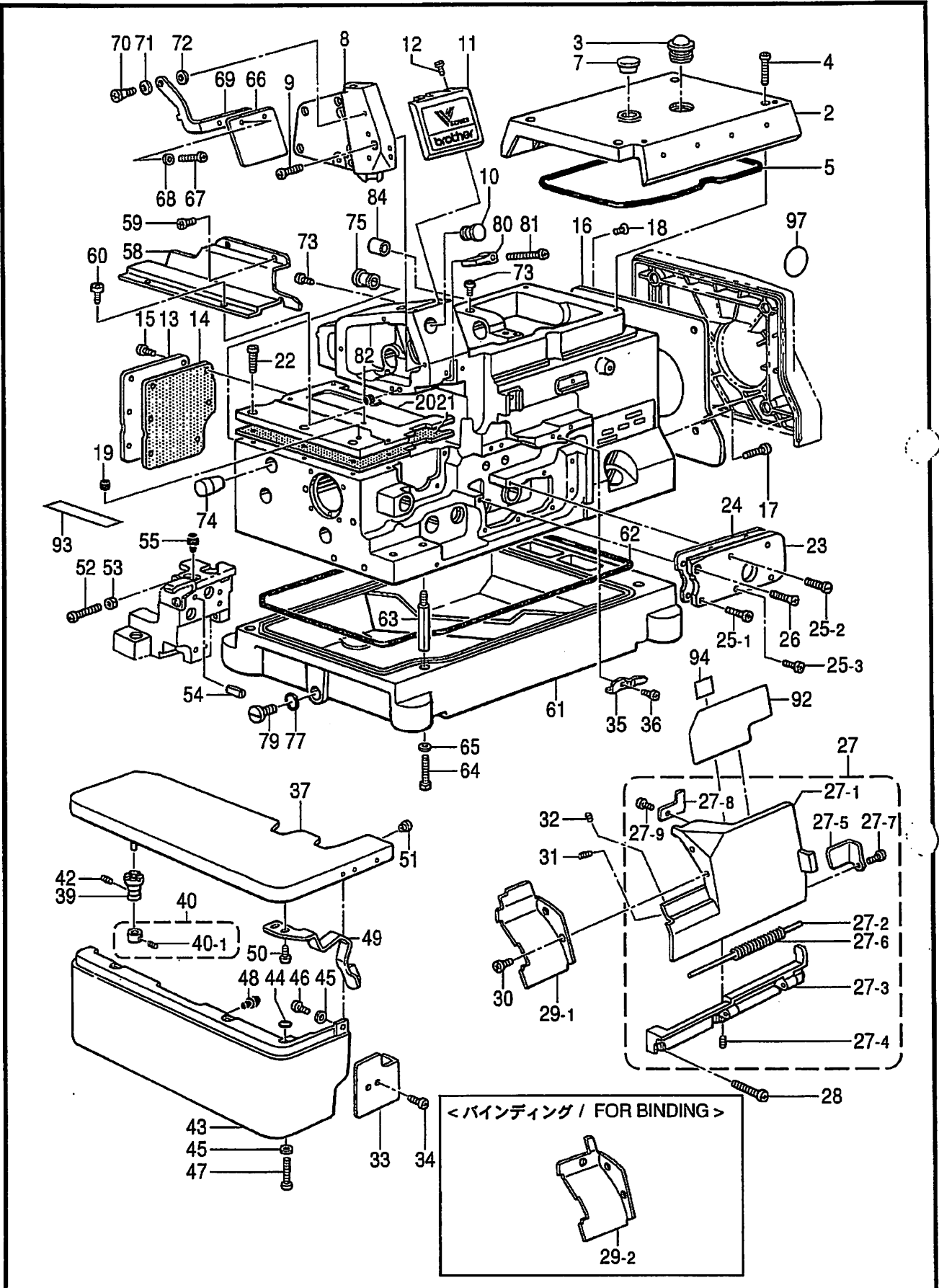

878-V6A-052

A. 主体関係 / Machine body

REF.NO.	CODE	Q'TY	ヒンメイ	NAME OF PARTS	RM
2	S20305001	1	ウワカバー	TOP COVER	
3	S02606000	1	ユリヨウケイマド	OIL GAUGE WINDOW	
4	062401212	4	ナベコ4X12	SCREW, PAN M4X12	
5	S20306000	1	ハツキン	PACKING	
7	S23337009	1	ゴムセン18.5	RUBBER CAP, 18.5	
8	S39607001	1	ソクメンカバー	FRAME SIDE COVER	
9	062400812	5	ナベコ4X8	SCREW, PAN M4X8	
10	S20345009	1	ゴムセン14	RUBBER CAP, 14	
11	S20309101	1	メンイタカバー	FACE PLATE COVER	
12	060400612	2	バインドM4X6	SCREW, BIND M4X6	
13	S20310001	1	オクリキコウカバーB	COVER, FEED MECHANISM (B)	
14	S20311000	1	ハツキン	PACKING	
15	060400812	6	バインドM4X8	SCREW, BIND M4X8	
16	S23367001	1	ファンカバー	FAN COVER	
17	060400812	2	バインドM4X8	SCREW, BIND M4X8	
18	061400812	1	サラコM4X8	SCREW, FLAT M4X8	
19	S20878000	1	ゴムセン5.3	RUBBER CAP, 5.3	
20	S20313000	1	オクリダイカバー	FEED BAR COVER	
21	S20314000	1	ハツキン	PACKING	
22	062401012	6	ナベコM4X10	SCREW, PAN M4X10	
23	S39564021	1	ウチカバー	INSIDE COVER	
24	S44536000	1	ウチカバーハツキン	PACKING, INSIDE COVER	
25-1	060401012	3	バインドM4X10	SCREW, BIND M4X10	
25-2	S23616101	1	シメネジ4X10	SCREW, M4X10	
25-3	S44535001	1	バインドM4X8シール	SCREW, BIND M4X8 SEAL	
26	061400812	1	サラコM4X8	SCREW, FLAT M4X8	
27	S39611001	1	マエカバーLクミ	FRONT COVER ASSY, L	
27-1	S39612001	1	マエカバーL	FRONT COVER, L	
27-2	S39613001	1	マエカバーヒンジジク	HINGE SHAFT, FRONT COVER	
27-3	S20319001	1	マエカバーヒンジ	HINGE, FRONT COVER	
27-4	012400432	2	アナヒラ4X4	SET SCREW, SOCKET (FT) M4X4	
27-5	S20320101	1	マエカバーストツバ	STOPPER, FRONT COVER	
27-6	S20321001	1	マエカバーバネ	SPRING, FRONT COVER	
27-7	060400612	1	バインドM4X6	SCREW, BIND M4X6	
27-8	S20327101	1	マエカパートメイタ	STOPPER PLATE, FRONT COVER	
27-9	060400612	1	バインドM4X6	SCREW, BIND M4X6	
28	060401412	3	バインドM4X14	SCREW, BIND M4X14	
29-1	S38305001	1	マエカバーS	FRONT COVER, S	
29-2	S42050001	1	マエカバーS	FRONT COVER, S	
30	062400612	2	ナベコM4X6	SCREW, PAN M4X6	
31	012400832	1	アナヒラ4X8	SET SCREW, SOCKET (FT) M4X8	
32	012400432	1	アナヒラ4X4	SET SCREW, SOCKET (FT) M4X4	
33	S20324101	1	マエカバーLアンナイ	FRONT COVER GUIDE, L	
34	060400612	2	バインドM4X6	SCREW, BIND M4X6	
35	S20325001	1	マエカパートメイタバネ	PLATE SPRING	
36	060400612	1	バインドM4X6	SCREW, BIND M4X6	
37	S20328001	1	クロスプレート	CLOTH PLATE	
39	S20330100	1	クロスプレートササエカラー	SUPPORT COLLAR, CLOTH PLATE	
40	S20331001	1	セットカラークミ	SET SCREW COLLAR ASSY	
40-1	012400432	1	アナヒラ4X4	SET SCREW, SOCKET (FT) M4X4	
42	012400632	1	アナヒラ4X6	SET SCREW, SOCKET (FT) M4X6	
43	S20334000	1	クロスプレートシタ	CLOTH PLATE, LOWER	
44	118770001	3	ハツキン	PACKING	
45	025040132	4	ヒラザガネシヨウ4	WASHER, PLAIN S 4	
46	060400612	1	バインドM4X6	SCREW, BIND M4X6	
47	060401012	3	バインドM4X10	SCREW, BIND M4X10	
48	S20412000	2	ゴムセン3.7	RUBBER CAP, 3.7	
49	S39625151	1	クロスプレートトメイタバネ	SPRING, PLATE	

878-V6A-052

A. 主体関係 / Machine body

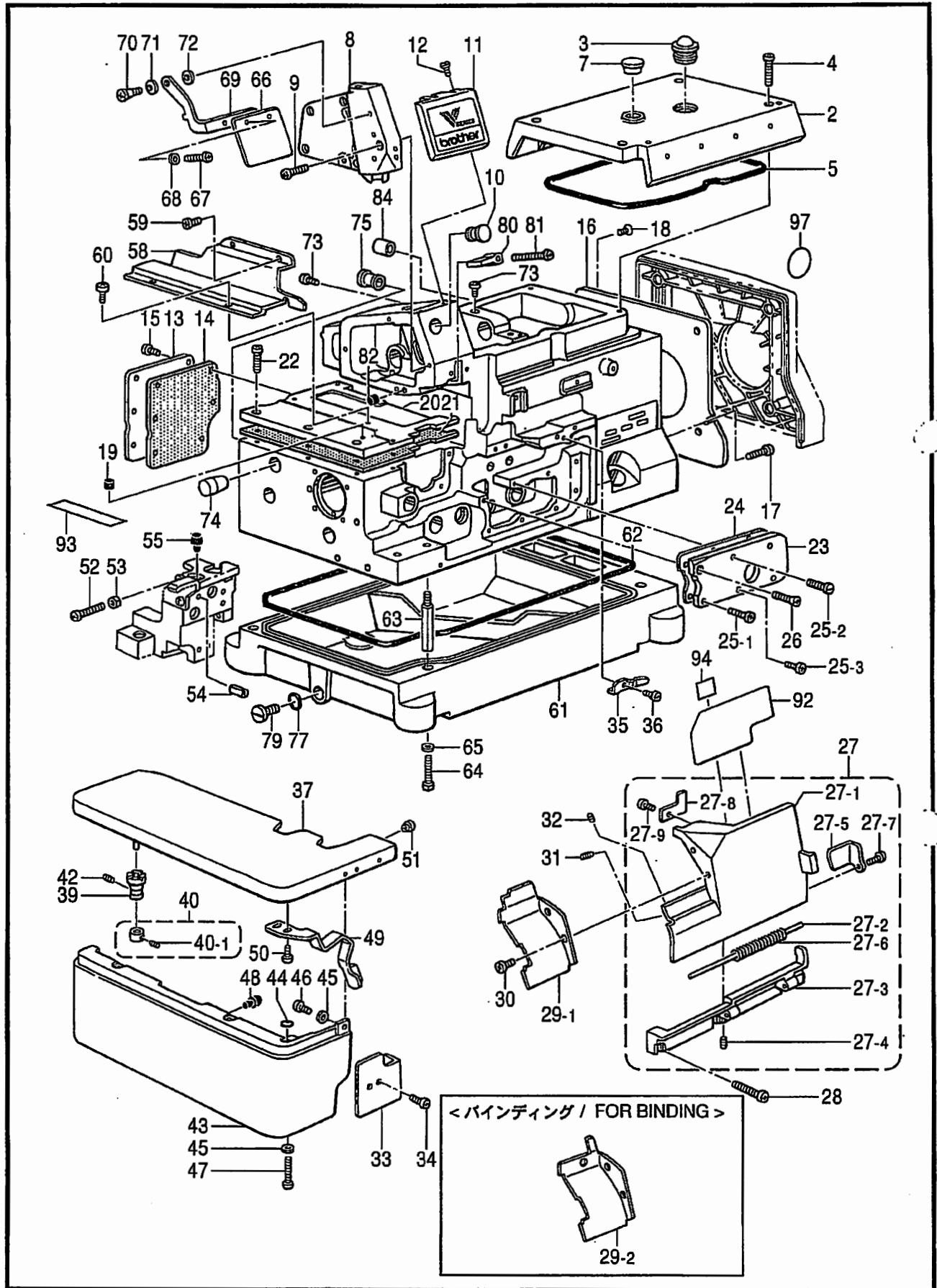

A. 主体関係 / Machine body

REF.NO.	CODE	QTY	ヒンメイ	NAME OF PARTS	RM
50	060400612	2	バインドM4X6	SCREW, BIND M4X6	
51	156482000	1	セン4	CAP, 4	
52	062401212	1	ナベコ4X12	SCREW, PAN M4X12	
53	021400212	1	2シユナツト4	NUT, 2 M4	
54	047602042	1	スプリングピン6X20	PIN, SPRING ROLL 6X10	
55	S20412000	1	ゴムセン3.7	RUBBER CAP, 3.7	
58	S39626021	1	クロスプレートヌノアンナイ	CLOTH GUIDE	
59	060400612	2	バインドM4X6	SCREW, BIND M4X6	
60	060400512	1	バインドM4X5	SCREW, BIND M4X5	
61	S20338200	1	アブラウケ	OIL PAN	
62	S20339000	1	パツキン	PACKING	
63	S23350001	4	ホンタイシチユウ	MACHINE BODY LEG	
64	017501212	4	ボルト5X12	BOLT, M5X12	
65	S23351001	4	ザガネ	WASHER	
66	S00075000	1	アイガード	EYE GUARD	
67	060350812	2	バインド35X8	SCREW, BIND M3.5X8	
68	025350332	2	ヒラザガネダイ3.5	WASHER, PLAIN L 3.5	
69	S20340001	1	アイガードササエイタ	EYE GUARD SUPPORT PLATE	
70	S20342001	1	ダンネジ4	SHOULDER SCREW, M4	
71	146598001	1	バネザガネ	WASHER, SPRING	
72	025050132	1	ヒラザガネシヨウ5	WASHER, PLAIN S 5	
73	S30517101	5	ナベコシール6X10	SCREW, PAN M6X10 SEAL	
74	S20344009	1	ゴムセン16	RUBBER CAP, 16	
75	S20345009	1	ゴムセン14	RUBBER CAP, 14	
77	081009070	1	OリングP9	O RING, P9	
79	S23357001	1	シメネジ10	SCREW, M10	
80	S20346000	1	ハリボウアブラウケ	NEEDLE BAR OIL RESERVOIR	
81	062401612	1	ナベコM4X16	SCREW, PAN M4X16	
82	S20878000	1	ゴムセン5.3	RUBBER CAP, 5.3	
84	S07477009	1	ゴムリング	RUBBER RING	
92	S25182001	1	<5本兼用> イトトオシセツメイラベルD	<FOR "5THREADS"> THREADING DIAGRAM LABEL, D	
92	S25183001	1	<4本兼用> イトトオシセツメイラベルE	<FOR "4THREADS"> THREADING DIAGRAM LABEL, E	
92	S31867001	1	<6本兼用> イトトオシセツメイラベルF	<FOR "6THREADS"> THREADING DIAGRAM LABEL, F	
93	S25184001	1	DLイトトオシセツメイラベル	THREADING DIAGRAM LABEL, DL	
4	S44821001	1	セイソウシジラベル	LABEL, CLEANING	
97	S43453001	1	フィルタコウカンシジラベル	LABEL, CLEANING FILTER	

B. 駆動軸関係 / Driving shaft mechanism

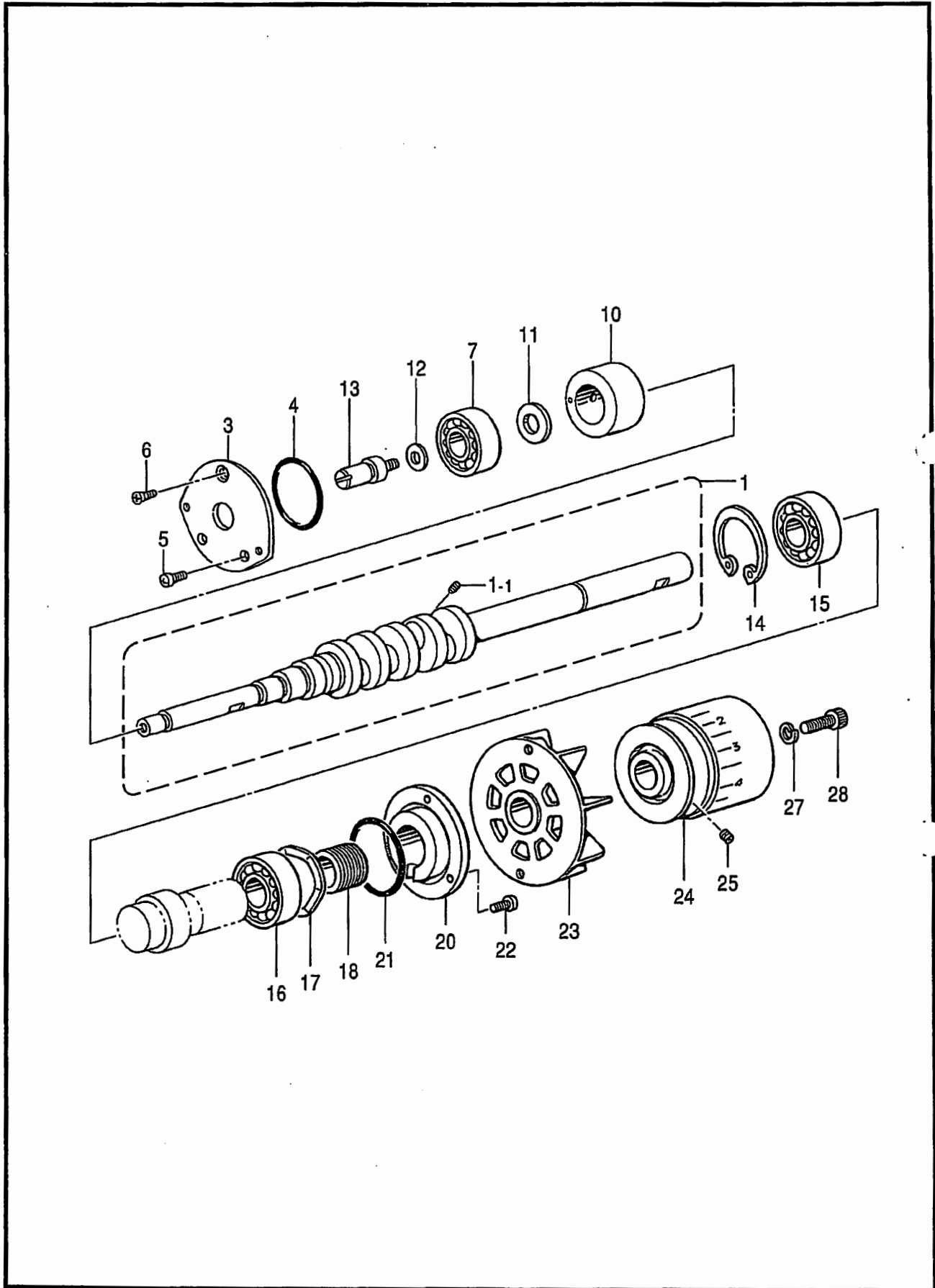

B. 駆動軸関係 / Crankshaft mechanism

REF.NO.	CODE	Q'TY	ヒンメイ	NAME OF PARTS	RM
1	S46921001	1	<スタンダード、ハイリフト用> クドウジクOネジツキ	< FOR STANDARD & HIGH-LIFT > CRANKSHAFT, O W/SCREW	
1	S46922001	1	<超ハイリフト用> クドウジクPネジツキ	< FOR EXTRA HIGH-LIFT > CRANKSHAFT, P W/SCREW	
1-1	S25530001	1	アナクボミ2.5X4	SET SCREW, SOCKET M2.5X14	
3	S39629021	1	ベアリングフタ	BEARIG CAP	
4	081031870	1	Oリング S31.5	O RING, S31.5	
5	062400812	2	ナベコ4X8	SCREW, PAN M4X8	
6	061400812	1	サラコM4X8	SCREW, FLAT M4X8	
7	072600000	1	タマジクウケ6000	BALL BEARING, 6000	
10	S39630000	1	クドウジクメタル	CRANKSHAFT BUSH	
11	S20356001	1	ヒラザガネ10	WASHER, PLAIN 10	
12	155559001	1	ヒラザガネ	WASHER, PLAIN	
13	S46900001	1	ニジユウカンテンビンジク	D-CHAIN STITCH THR. TAKE-UP SHAFT	
14	048400242	1	トメワアナヨウC40	RETAINING RING, C40	
15	076203000	1	タマジクウケ6203	BALL BEARING, 6203	
16	S27868001	1	タマジクウケ6203V	BALL BEARING, 6203V	
17	S20361001	1	ナミバネ	SPRING, WAVE	
18	S20362151	1	クドウジクオイルキリ	CRANKSHAFT OIL REJECTOR	
20	S39631000	1	ベアリングオサエ	BEARING PRESSER	
21	S20353000	1	Oリング	O RING	
22	062401012	3	ナベコM4X10	SCREW, PAN M4X10	
23	S20366000	1	ファン	FAN	
24	S39565101	1	プーリ	PULLEY	
25	012060632	2	アナヒラ6X6	SET SCREW, SOCKET (FT) M6X6	
27	028060242	1	バネザガネ2-6	WASHER, SPRING 2-6	
28	018062532	1	アナホルト6X25	BOLT, SOCKET M6X25	

C. 針棒關係 / Needle bar mechanism

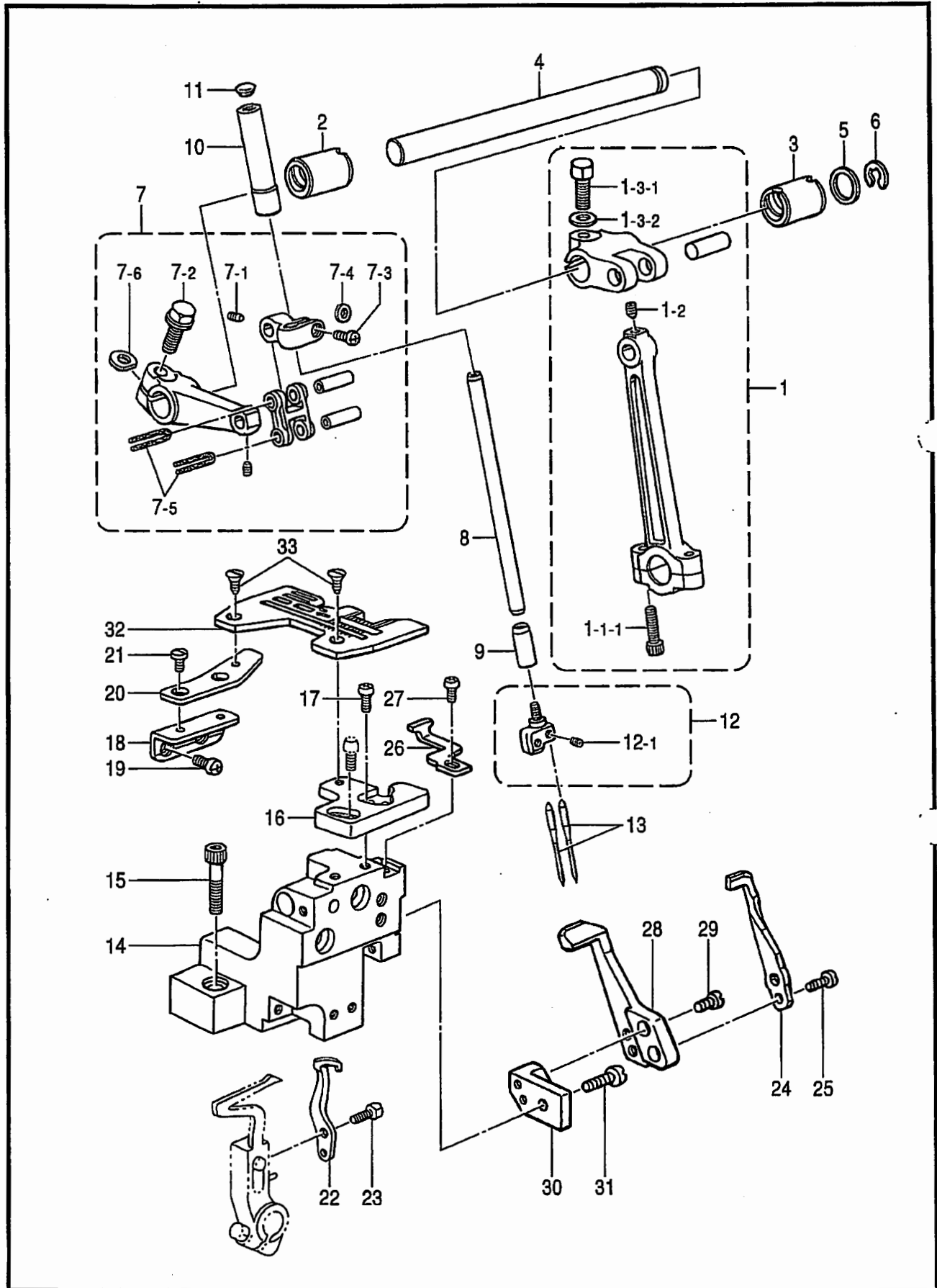

C. 針棒関係 / Needle bar mechanism

REF.NO.	CODE	Q'TY	ヒンメイ	NAME OF PARTS	RM
1	S46928001	1	<スタンダード用> ハリクランクロッドクミS	<FOR STANDARD> N-DRIVING CRANK ROD ASSY, S	
1	S46931001	1	<ハイリフト用> ハリクランクロッドクミH	<FOR HIGH-LIFT> N-DRIVING CRANK ROD ASSY, H	
1	S46932001	1	<超ハイリフト用> ハリクランクロッドクミE	<FOR EXTRA HIGH-LIFT> N-DRIVING CRNK ROD ASSY, E	
1-1-1	018401622	2	アナボルト4X16	BOLT, SOCKET M4X16	
1-2	S23342001	1	アナトガリ4X5	SET SCREW, SOCKET (CN) M4X5	
1-3-1	017061612	1	ボルト6X16	BOLT, M6X16	
1-3-2	118735002	1	ザガネ	WASHER	
2	S39644021	1	ハリジクメタルL	NEEDLE SHAFT BUSH, L	
3	S39645021	1	ハリジクメタルR	NEEDLE SHAFT BUSH, R	
4	S39646021	1	ハリジク	NEEDLE SHAFT	
5	S39647000	1	ザガネ	WASHER	
6	146293001	1	トメワE10	RETAINING RING, E10	
7	S20386101	1	ハリボウダキクミ	NEEDLE BAR CLAMP ASSY	
7-1	S23342001	2	アナトガリ4X5	SET SCREW, SOCKET (CN) M4X5	
7-2	S46899001	1	ザガネツキボルト6X16	BOLT, (S/P WASHER) M6X16	
7-3	062350812	1	ナベコ3.5X8	SCREW, PAN M3.5X8	
7-4	S20391001	1	スペーサ	SPACER	
7-5	S20392000	2	フェルト	FELT	
7-6	155162001	1	スペーサ	SPACER	
8	S20393101	1	ハリボウ	NEEDLE BAR	
9	S39648021	1	ハリボウメタルD	NEEDLE BAR BUSH, D	
10	S39571021	1	ハリボウメタルU	NEEDLE BAR BUSH, U	
11	104450101	1	ゴムセン8	RUBBER CAP, 8	
12	※	1	ハリドメクミ	NEEDLE CLAMP ASSY	
12-1	146427001	2	アナトメネジ3.18クボミ	SET SCREW, SOCKET (CP) SM3.18	
13	※	2	ミジンハリ DCX27	NEEDLE, DCX27	
14	S39649021	1	ハリイタササエダイ	NEEDLE PLATE SUPPORT BRACKET	
15	018062532	2	アナホルト6X25	BOLT, SOCKET M6X25	
16	S39650051	1	ハリイタササエイタF	NEEDLE PLATE SUPPORT, F	
17	062401012	2	ナベコM4X10	SCREW, PAN M4X10	
18	S20413051	1	ハリイタササエイタBササエ	SUPPORT, B N-PLATE SUPPORT	
19	062400612	2	ナベコM4X6	SCREW, PAN M4X6	
20	S20414001	1	ハリイタササエイタB	SUPPORT PLATE, B NEEDLE PLATE	
21	S23418002	2	シメネジ4X5	SCREW, M4X5	
22	S20415101	1	イドウハリウケ	NEEDLE GUARD, MOVABLE	
23	S20416101	1	ボルト3.5X10	BOLT, M3.5X10	
24	S20418051	1	オーバーハリウケF	NEEDLE GUARD, F	
25	S23456101	2	ナベコ2.5X6	SCREW, PAN M2.5X6	
26	S38306051	1	ニジユウカンハリウケF	CHAIN STITCH NEEDLE GUARD, F	
27	062350812	1	ナベコ3.5X8	SCREW, PAN M3.5X8	
28	S38307001	1	ニジユウカンハリウケB	CHAIN STITCH NEEDLE GUARD, B	
29	062300812	2	ナベコ3X8	SCREW, PAN M3X8	
30	S39654051	1	ハリウケブラケット	NEEDLE GUARD BRACKET	
31	062401012	1	ナベコM4X10	SCREW, PAN M4X10	
32	※	1	ハリイタ	NEEDLE PLATE	
33	100032003	2	サラネジ4.37	SCREW, FLAT SM4.37	

D. 押工関係 / Presser foot mechanism

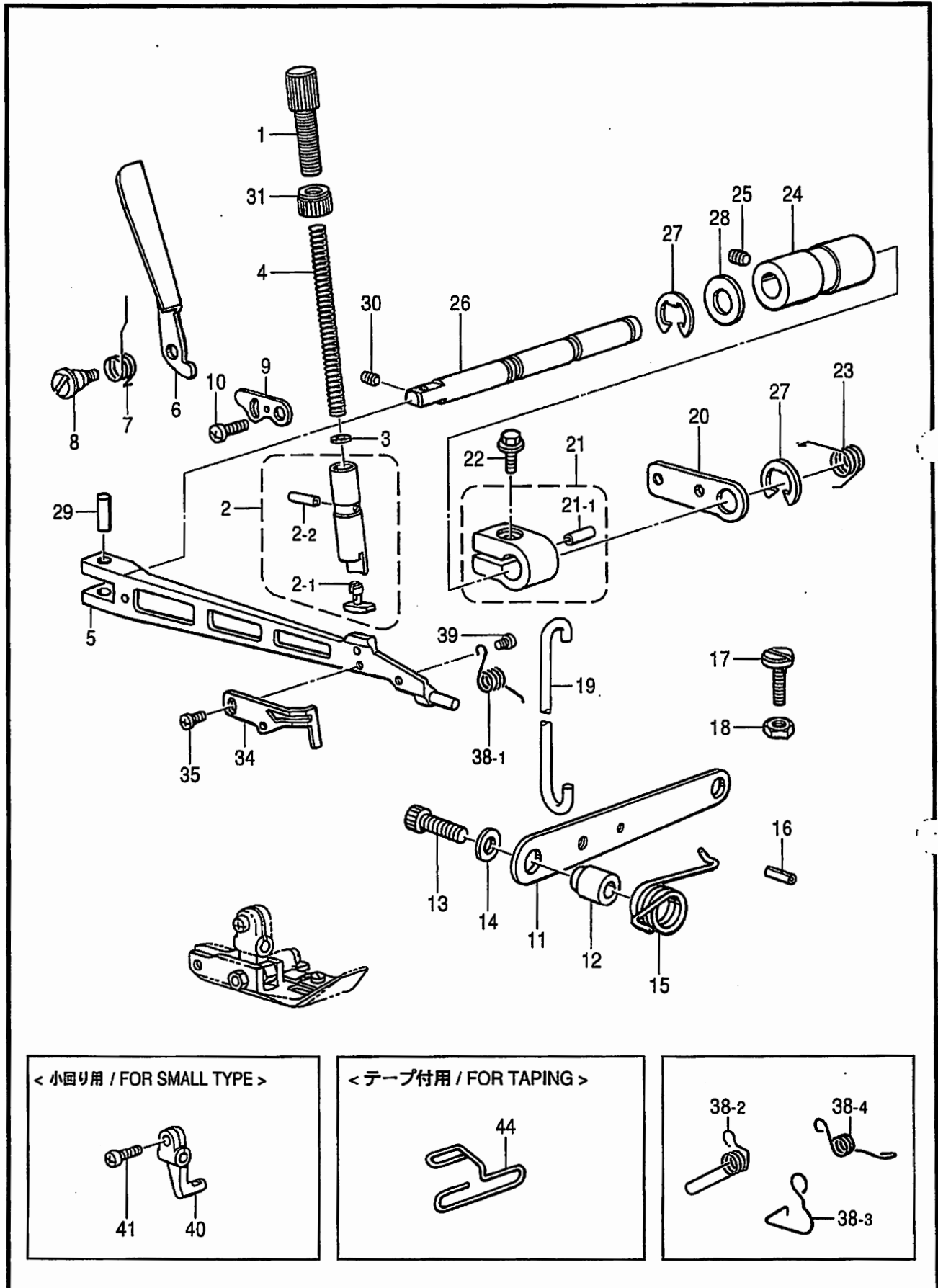

D. 押工関係 / Presser foot mechanism

REF.NO.	CODE	Q'TY	ヒンメイ	NAME OF PARTS	RM
1	S20472001	1	オサエチヨウセツネジ	ADJUSTING SCREW	
2	S46887001	1	オサエボウクミ	PRESSER BAR ASSY	
2-1	S39577000	1	オサエクツシヨン	CUSHION	
2-2	047301642	1	スプリングピンAW3	PIN, SPRING ROLL AW3	
3	105161004	1	ザガネ	WASHER	
4-1	S20476001	1	オサエバネ	PRESSER SPRING	
			<SS用>	<FOR NEW SYNTHETIC FIBER >	
4-2	S20477001	1	オサエバネ	PRESSER SPRING	
5	S46889001	1	シユオサエウデ	MAIN PRESSER ARM	
6	S39659021	1	オサエテアゲ	PRESSER BAR LIFTER	
7	S39660001	1	オサエテアゲバネ	SPRING, PRESSER BAR LIFTER	
8	S39661001	1	ダンネジ4	SHOULDER SCREW, M4	
9	S39662001	1	シユオサエウデストツハ	MAIN PRESSER ARM STOPPER	
10	060400612	1	バインドM4X6	SCREW, BIND M4X6	
11	S39663021	1	オサエアジアゲレバー	PRESSER FOOT LIFTER LEVER	
12	S39664001	1	オサエアジアゲレバーカラー	COLLAR	
13	018062532	1	アナホルト6X25	BOLT, SOCKET M6X25	
14	025060332	1	ヒラザガネダイ6	WASHER, PLAIN L 6	
15	S39665001	1	オサエアジアゲレバーバネ	SPRING	
16	047502542	1	スプリングピンAW5	PIN, SPRING ROLL AW5	
17	S39770001	1	シメネジ4	SCREW, M4	
18	021400212	1	2シユナツト4	NUT, 2 M4	
19	S20485001	1	オサエアゲリンク	PRESSER BAR LIFTER LINK	
20	S39666001	1	オサエアゲレバー	PRESSER BAR LIFTER LEVER	
21	S46849001	1	オサエアゲウデクミ	PRESSER BAR LIFTER ARM ASSY	
21-1	047401642	1	スプリングピンAW4	PIN, SPRING ROLL AW4	
22	S46899001	1	ザガネツキボルト6X16	BOLT, (S/P WASHER) M6X16	
23	S39669101	1	オサエアゲレバーバネ	SPRING, PRESSER LIFTER LEVER	
24	S39670000	1	オサエウデジクメタル	PRESSER ARM SHAFT BUSH	
25	012060632	1	アナヒラ6X6	SET SCREW, SOCKET (FT) M6X6	
26	S39671101	1	オサエウデジク	PRESSER ARM SHAFT	
27	048090342	2	トメワE9	RETAINING RING, E9	
28	S30562000	1	ザガネ	WASHER	
29	S39672001	1	オサエウデピン	PRESSER ARM PIN	
30	012400432	1	アナヒラ4X4	SET SCREW, SOCKET (FT) M4X4	
31	S23341009	1	チヨウセツネジツマミナツト	NUT	
34	S37070121	1	フィンガーガードV	FINGER GUARD, V	
5	060300412	1	バインドM3X4	SCREW, BIND M3X4	
38-1	S44744001	1	オサエネジリバネ	SPRING, TWIST	
			<デニム用>	<FOR HEAVY>	
38-2	S20115001	1	オサエネジリバネ	SPRING, TWIST	
			<デニムタテポケット用>	<FOR HEAVY VERTICAL POCKET>	
38-3	S20117001	1	オサエネジリバネ	SPRING, TWIST	
			<小回り用>	<FOR SMALL TYPE>	
38-4	S30889001	1	オサエネジリバネ	SPRING, TWIST	
39	060300612	1	バインドM3X6	SCREW, BIND M3X6	
			<小回り用>	<FOR SMALL TYPE>	
40	S30888001	1	フクオサエウデ	SUB PRESSER ARM	
41	062670712	1	ナベコ357-40X7	SCREW, PAN SM3.57-40X7	
			<テープ付け用>	<FOR TAPING>	
44	S23364000	1	テープアンナイ	TAPE GUIDE	

D . 押工関係 / Presser foot mechanism

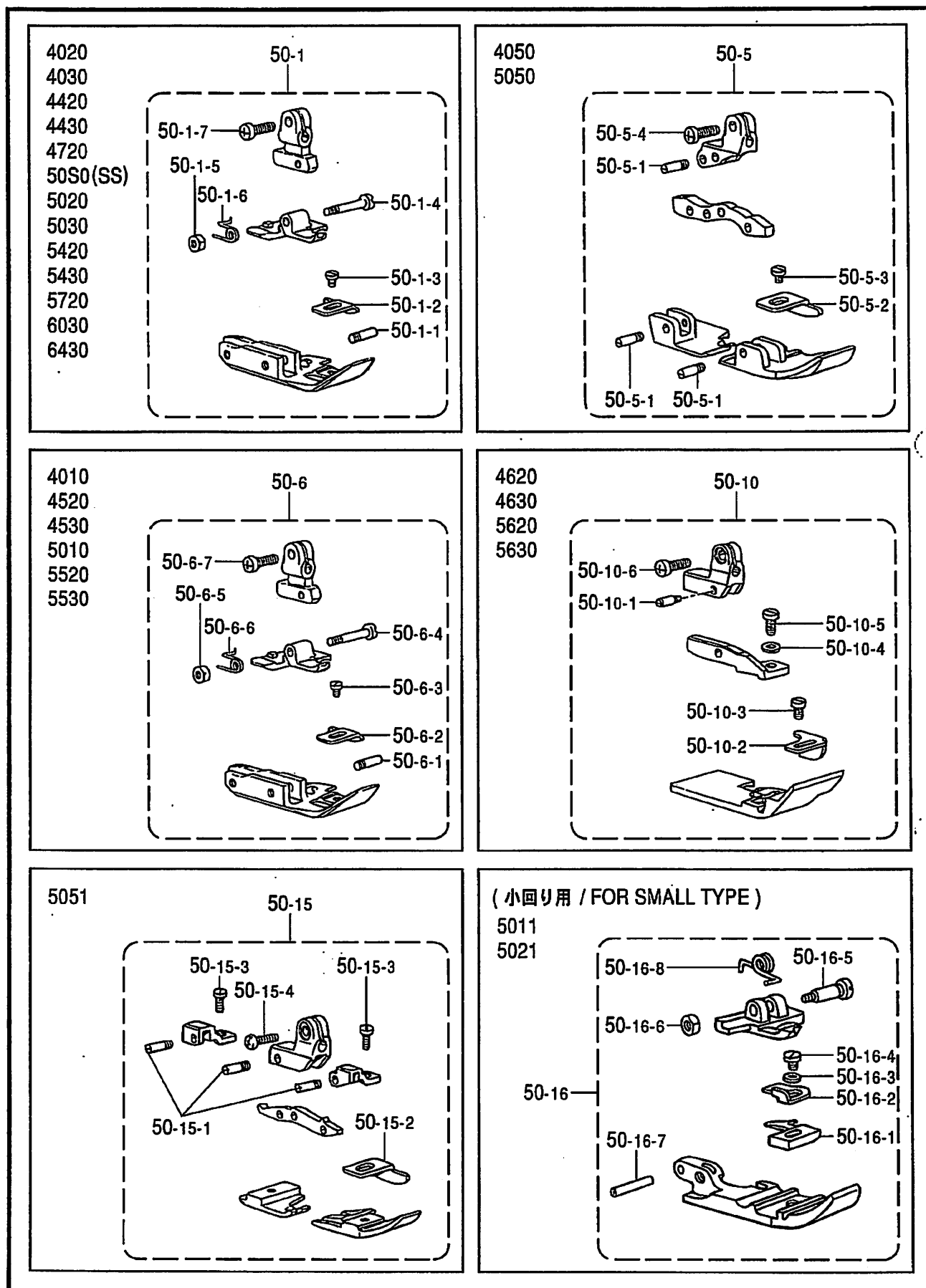

D. 押工関係 / Presser foot mechanism

REF.NO.	CODE	Q'TY	ヒンメイ	NAME OF PARTS	RM
			<4020,4030,4420,4430,4720,5050 (SS), 5020,5030,5420,5430,5720,6030,6430>		
50-1	※	1	オサエクミ	PRESSER FOOT ASSY	
50-1-1	S19311101	1	オサエササエネジ	SCREW	
50-1-2	※	1	オサエF	PRESSER FOOT, F	
50-1-3	105288001	1	シメネジ2.38	SCREW, SM2.38	
50-1-4	S19307001	1	オサエBササエネジ	SCREW	
50-1-5	S19308001	1	2シユナツト318-44	NUT, 2 SM3.18-44	
50-1-6	S19309001	1	オサエBネジリバネ	SPRING, TWIST	
50-1-7	062670712	1	ナベコ357-40X7	SCREW, PAN SM3.57-40X7	
			<4050,5050>		
50-5	※	1	オサエクミ	PRESSER FOOT ASSY	
50-5-1	S19311101	3	オサエササエネジ	SCREW	
50-5-2	※	1	オサエF	PRESSER FOOT, F	
50-5-3	106640001	1	シメネジ3.18	SCREW, SM3.18	
50-5-4	062670712	1	ナベコ357-40X7	SCREW, PAN SM3.57-40X7	
			<4010,4520,4530,5010,5520,5530>		
50-6	※	1	オサエクミ	PRESSER FOOT ASSY	
50-6-1	S19311101	1	オサエササエネジ	SCREW	
50-6-2	※	1	オサエF	PRESSER FOOT, F	
50-6-3	140530002	1	シメネジ2.38	SCREW, SM2.38	
50-6-4	S19307001	1	オサエBササエネジ	SCREW	
50-6-5	S19308001	1	2シユナツト318-44	NUT, 2 SM3.18-44	
50-6-6	S19309001	1	オサエBネジリバネ	SPRING, TWIST	
50-6-7	062670712	1	ナベコ357-40X7	SCREW, PAN SM3.57-40X7	
			<4620,4630,5620,5630>		
50-10	※	1	オサエクミ	PRESSER FOOT ASSY	
50-10-1	S19311101	1	オサエササエネジ	SCREW	
50-10-2	※	1	オサエF	PRESSER FOOT, F	
50-10-3	105288001	1	シメネジ2.38	SCREW, SM2.38	
50-10-4	025660132	1	ヒラザガネシヨウ3.18	WASHER, PLAIN S 3.18	
50-10-5	106640001	1	シメネジ3.18	SCREW, SM3.18	
50-10-6	062670712	1	ナベコ357-40X7	SCREW, PAN SM3.57-40X7	
			<5051>		
50-15	※	1	オサエクミ	PRESSER FOOT ASSY	
50-15-1	S19311101	3	オサエササエネジ	SCREW	
50-15-2	※	1	オサエF	PRESSER FOOT, F	
50-15-3	100080004	2	シメネジ3.18	SCREW, SM3.18	
50-15-4	062670712	1	ナベコ357-40X7	SCREW, PAN SM3.57-40X7	
			<5011,5021 小回り用>	<5011,5021 FOR SMALL TYPE>	
50-16	※	1	オサエクミ	PRESSER FOOT ASSY	
50-16-1	※	1	ツメ	STITCH TONGUE	
50-16-2	S19368001	1	オサエトリツケイタ	PRESSER FOOT PLATE	
50-16-3	025030132	1	ヒラザガネシヨウ3	WASHER, PLAIN S 3	
50-16-4	150755001	1	シメネジ3.18	SCREW, SM3.18	
50-16-5	S30590001	1	オサエBササエネジ	SUPPORT SCREW	
50-16-6	500296002	1	ナツト	NUT	
50-16-7	047161042	1	スプリングピンAW1.6	PIN, SPRING ROLL AW1.6	
50-16-8	S30591001	1	オサエBネジリバネ	TWIST SPRING	

E. 送り関係 / Feed mechanism

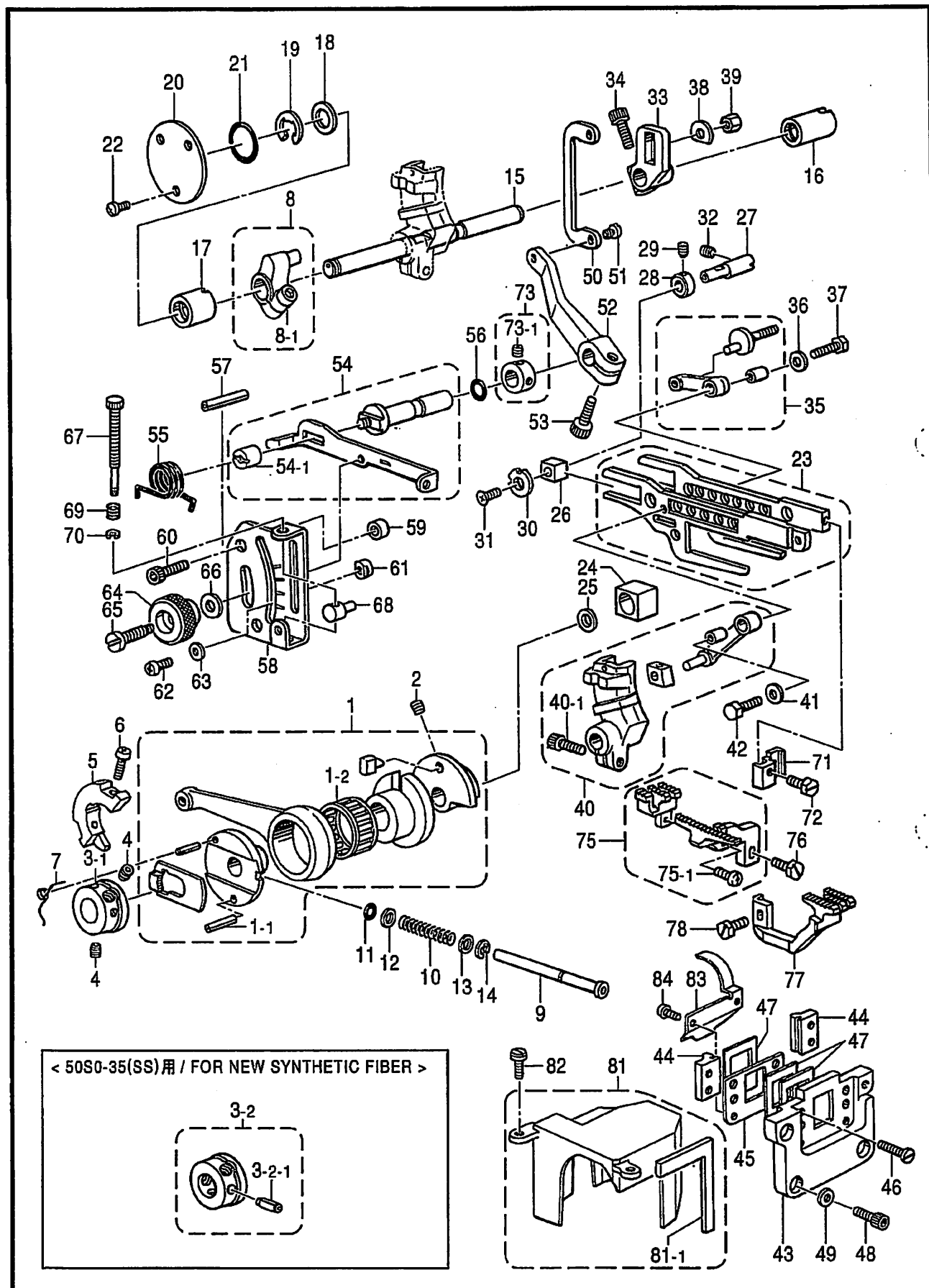

E. 送り関係 / Feed mechanism

REF.NO.	CODE	Q'TY	ヒンメイ	NAME OF PARTS	RM
1	S20496101	1	ヘンシンリンクミ	ECCENTRIC LINK ASSY	
1-1	047250842	1	スプリングピンAW2.5	PIN, SPRING ROLL AW2.5	
1-2	S20500001	1	ニードルジクウケ24 (赤)	NEEDLE BEARING, 24 RED	
1-2	S20500002	1	ニードルジクウケ24 (青)	NEEDLE BEARING, 24 BLUE	
1-2	S20500003	1	ニードルジクウケ24 (白)	NEEDLE BEARING, 24 WHITE	
2	012060632	2	アナヒラ6X6	SET SCREW, SOCKET (FT) M6X6	
3-1	S20507001	1	ラチエツト	RATCHET	
4	012060632	2	アナヒラ6X6	SET SCREW, SOCKET (FT) M6X6	
5	S23615001	1	バランスウエイト	BALANCE WEIGHT	
6	062401012	2	ナベコM4X10	SCREW, PAN M4X10	
7	S23458101	1	ラチエツトトメネジリバネ	SPRING, TWIST	
8	S39589021	1	オクリウデクミ	FEED ARM ASSY	
8-1	018061632	1	アナボルト6X16	BOLT, SOCKET M6X16	
9	S39674001	1	オクリチヨウセツボタンジク	FEED ADJUSTING SHAFT	
10	S39675001	1	ボタンジクバネ	SPRING	
11	081005070	1	OリングP5	O RING, P5	
12	025710232	1	ヒラザガネチユウ4.76	WASHER, PLAIN M 4.76	
13	025710232	1	ヒラザガネチユウ4.76	WASHER, PLAIN M 4.76	
14	048040342	1	トメワE4	RETAINING RING, E4	
15	S39676121	1	オクリジク	FEED SHAFT	
16	S39677021	1	メタル11.11-17	BUSH, 11.11-17	
17	S39678021	1	オクリジクメタルL	FEED SHAFT BUSH, L	
18	S30562000	1	ザガネ	WASHER	
19	048090342	1	トメワE9	RETAINING RING, E9	
20	S39679001	1	オクリジクメタルLフタ	CAP	
21	081020070	1	OリングP20	O RING, P20	
22	060400612	3	バインドM4X6	SCREW, BIND M4X6	
23	S46891001	1	オクリダイクミ	FEED BAR ASSY	
24	S38312050	1	ジヨウゲオクリカクゴマ	FEED LIFTING SLIDE BLOCK	
25	142628001	2	スイハイオクリクランクリング	FEED ROCK CRANK RING	
26	S39683000	1	オクリダイカクゴマ	FEED BAR SLIDE BLOCK	
27	S39684021	1	オクリダイカクコマジク	FEED BAR SLIDE BLOCK SHAFT	
28	S39685001	1	セツカラー	SET SCREW COLLAR	
29	012400432	1	アナヒラ4X4	SET SCREW, SOCKET (FT) M4X4	
30	S20530001	1	ザガネ	WASHER	
31	004350812	1	+サラコ35X8	SCREW, FLAT M3.5X8	
32	012400832	1	アナヒラ4X8	SET SCREW, SOCKET (FT) M4X8	
33	S42042021	1	シユオクリウデ	MAIN FEED ARM	
34	018061632	1	アナボルト6X16	BOLT, SOCKET M6X16	
35	S39773001	1	シユオクリリンククミ	MAIN FEED LINK ASSY	
36	S39690021	1	ザガネ	WASHER	
37	S23360001	1	ボルト5X15	BOLT, M5X15	
38	S02573000	1	ザガネ	WASHER	
39	S39691001	1	ナツト5	NUT, M5	
40	S39769051	1	サドウオクリウデリンククミ	DIF. FEED ARM LINK ASSY	
40-1	018061632	1	アナボルト6X16	BOLT, SOCKET M6X16	
41	S39690021	1	ザガネ	WASHER	
42	S23360001	1	ボルト5X15	BOLT, M5X15	
43	S20523000	1	オクリダイアンナイササエ	FEED BAR GUIDE SUPPORT	
44	S20524000	2	オクリダイアンナイ	FEED BAR GUIDE	
45	S20525001	1	ボウジンイタササエ	FRAGMENT PROTECTOR PLATE	
46	S20740101	4	シメネジ4X10シール	SCREW, SEAL M4X10	
47	S20526000	3	ボウジンイタ	FRAGMENT PROTECTOR PLATE	
48	S43916001	4	アナボルト4X8シール	BOLT, SOCKET M4X8 SEAL	
49	025040132	4	ヒラザガネシヨウ4	WASHER, PLAIN S 4	
50	S39692021	1	サドウチヨウセツリンク	DIF. FEED ADJUSTING LINK	
51	S20543101	1	シメネジ5	SCREW, M5	
52	S20544000	1	サドウリンクレバー	DIFFERENTIAL LINK LEVER	
53	018061432	1	アナボルト6X14	BOLT, SOCKET M6X14	

E. 送り関係 / Feed mechanism

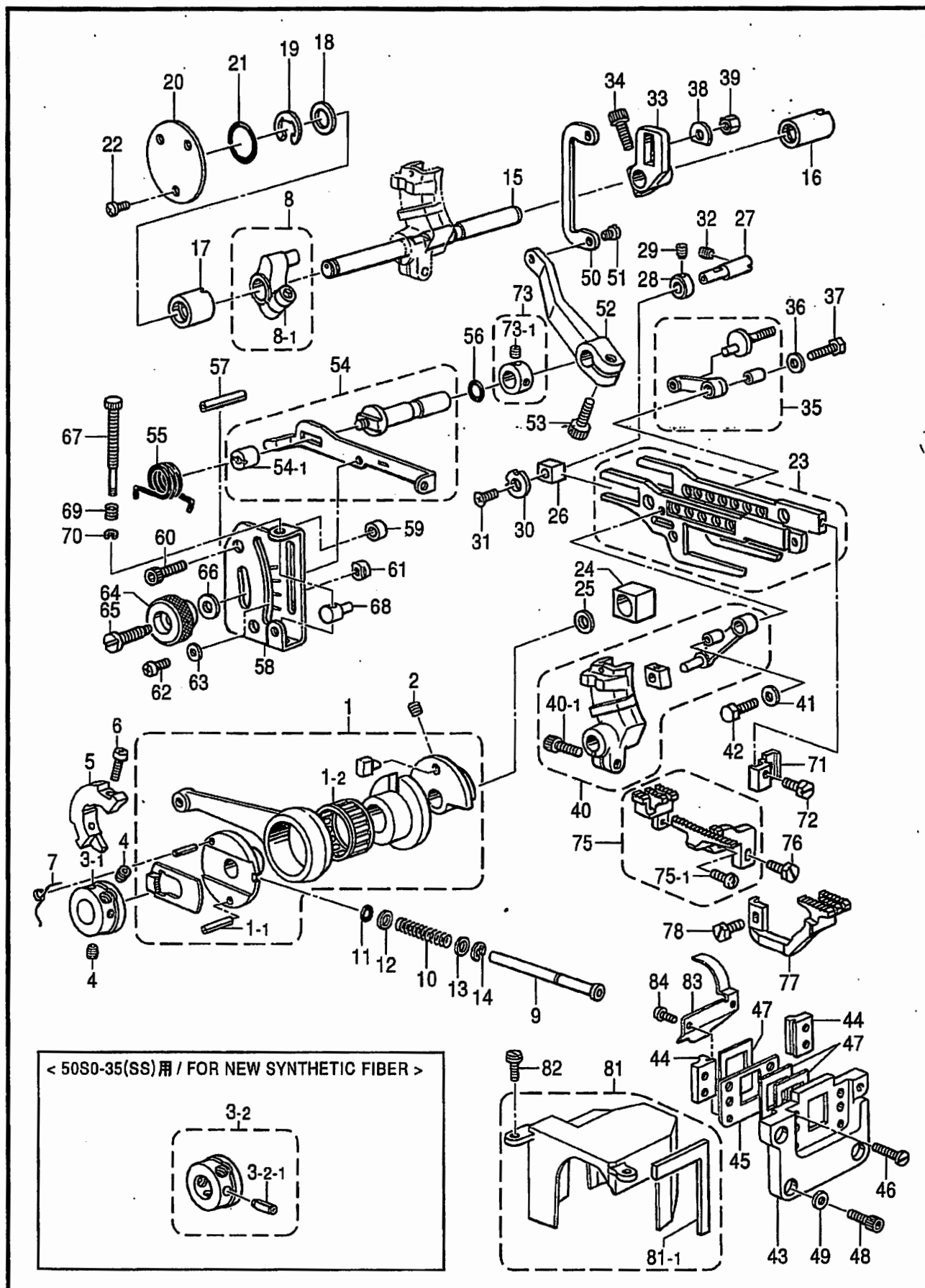

E. 送り関係 / Feed mechanism

REF.NO.	CODE	Q'TY	ヒンメイ	NAME OF PARTS	RM
54	S39593021	1	サドウチヨウセツレバークミ	DIF. FEED ADJUSTING LEVER ASSY	
54-1	S39596021	1	マルナツト6	NUT, ROUND M6	
55	S20547001	1	レバーバネ	SPRING	
56	081005670	1	OリングPW5	O RING, PW5	
57	047502542	1	スプリングピンAW5	PIN, SPRING ROLL AW5	
58	S20554001	1	サドウリヨウメモリイタ	DIF. STITCH CONTROL PLATE	
59	S20548001	2	カラー	COLLAR	
60	018061632	2	アナボルト6X16	BOLT, SOCKET M6X16	
61	S25818001	2	チヨウセツレバーストツバ	STOPPER, ADJUSTING LEVER	
62	060350812	2	バインド35X8	SCREW, BIND M3.5X8	
63	025350332	2	ヒラザガネダイ3.5	WASHER, PLAIN L 3.5	
64	S39694021	1	セツトネジツマミ	KNOB, SCREW	
65	S39695001	1	セツトネジ	SET SCREW	
66	S20560001	1	サラバネザガネ	WASHER, FLAT SPRING	
67	S20561001	1	マイクロチヨウセツネジ	SCREW, MICRO ADJUSTING	
68	S46895001	1	マイクロチヨウセツストツバ	STOPPER, MICRO ADJUST.	
69	S29094001	1	マイクロチヨウセツネジバネ	SPRING, MICRO ADJUST.	
70	048040342	1	トメワE4	RETAINING RING, E4	
71	S23628051	1	シユオクリバトリツケダイ	FEED DOG SETTING BASE	
72	S23621101	1	ボルト35X8	BOLT, M3.5X8	
73	S23612001	1	セツトカラークミ	SET SCREW COLLAR ASSY	
73-1	012060632	2	アナヒラ6X6	SET SCREW, SOCKET (FT) M6X6	
75	※	1	シユオクリバクミ	MAIN FEED DOG ASSY	
75-1	060630712	1	バインド238-56X7	SCREW, BIND SM2.38-56X7	
76	S23621101	1	ボルト35X8	BOLT, M3.5X8	
77	※	1	サドウオクリバ	DIFFERENTIAL FEED DOG	
78	S23621101	1	ボルト35X8	BOLT, M3.5X8	
81	S21091000	1	ヘンシンリンカバークミ	ECCENTRIC WHEEL COVER ASSY	
81-1	S21092000	1	カバースポンジ	COVER SPONGE	
82	S23616101	2	シメネジ4X10	SCREW, M4X10	
83	S20527001	1	アブラキリイタ	OIL REJECTOR PLATE	
84	S23453001	2	ナベコ3X5シール	SCREW, PAN M3X5 SEAL	
			<SS用>	<FOR NEW SYNTHETIC FIBER >	
3-2	S36864001	1	ラチエツトクミ	RATCHET ASSY	
3-2-1	047301042	1	スプリングピン	PIN, SPRING ROLL AW3	

G. 上メス・下メス関係 / Knife mechanism

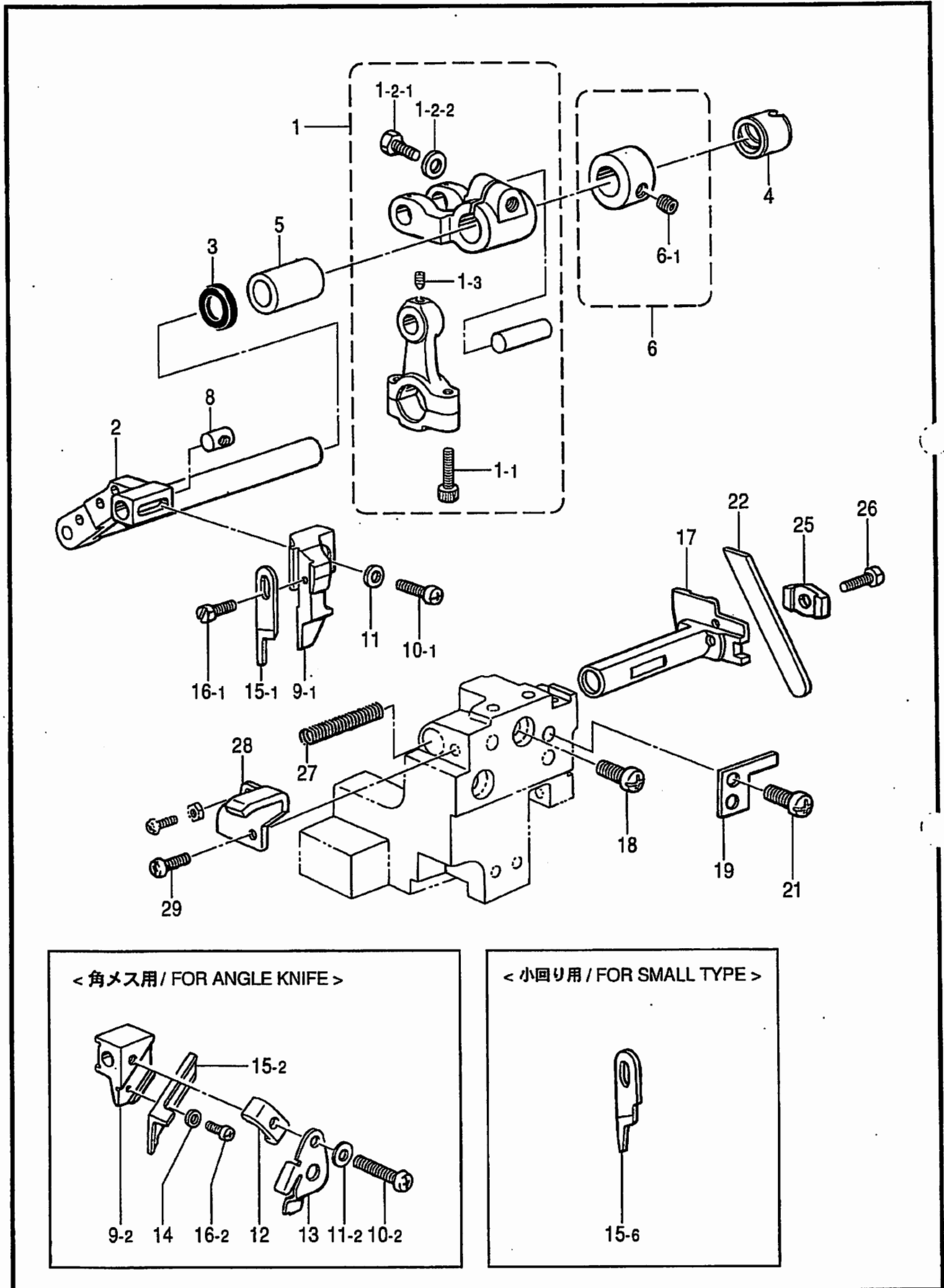

G. 上メス・下メス関係 / Knife mechanism

REF.NO.	CODE	Q'TY	ヒンメイ	NAME OF PARTS	RM
1	S46936001	1	ウワメスクランクロッドクミ	UPPER KNIFE CRANK ROD ASSY, I	
1-1	018401622	2	アナボルト4X16	BOLT, SOCKET M4X16	
1-2-1	017061612	1	ボルト6X16	BOLT, M6X16	
1-2-2	118735002	1	ザガネ	WASHER	
1-3	S23342001	1	アナトガリ4X5	SET SCREW, SOCKET (CN) M4X5	
2	S20571101	1	ウワメスサドウウデ	UPPER KNIFE DIFFERENTIAL ARM	
3	155247000	1	ダストシール	DUST SEAL	
4	S39704021	1	ウワメスメタルL	UPPER KNIFE BUSH L	
5	S39677021	1	メタル11.11-17	BUSH, 11.11-17	
6	S23619001	1	セツトカラークミ	SET SCREW COLLAR ASSY	
6-1	012060632	2	アナヒラ6X6	SET SCREW, SOCKET (FT) M6X6	
8	S20574001	1	ウワメスダキナツト	NUT	
17	S20591101	1	シタメストリツケダイ	LOWER KNIFE HOLDER	
18	062060812	1	ナベコ6X8	SCREW, PAN M6X8	
19	S39707001	1	シタメストリツケダイアンナイ	LOWER KNIFE HOLDER GUIDE	
21	062060812	2	ナベコ6X8	SCREW, PAN M6X8	
22	※	1	シタメス	LOWER KNIFE	
25	S39708001	1	シタメスオサエ	LOWER KNIFE PRESSER	
26	017500812	1	ボルト5X8	BOLT, M5X8	
27	S20585001	1	シタメストリツケダイバネ	SPRING	
28	S39709021	1	シタメスバネウケ	SPRING HOLDER	
29	060400812	1	バインドM4X8	SCREW, BIND M4X8	
			<平メス用部品>	<FOR PLAIN KNIFE>	
9-1	S20589101	1	ウワメスダキ	UPPER KNIFE HOLDER	
10-1	062401212	1	ナベコ4X12	SCREW, PAN M4X12	
11	025040132	1	ヒラザガネシヨウ4	WASHER, PLAIN S 4	
15-1	144074350	1	ウワメス	UPPER KNIFE	
16-1	S23621101	1	ボルト3.5X8	BOLT, M3.5X8	
			<小回り用>	<FOR SMALL TYPE>	
15-6	S30890000	1	ウワメス	UPPER KNIFE	
			<角メス用部品>	<FOR ANGLE KNIFE>	
9-2	S20590101	1	ウワメスダキ	UPPER KNIFE HOLDER	
10-2	062402512	1	ナベコM4X25	SCREW, PAN M4X25	
11-2	125324001	1	ヒラザガネダイ4アツ	WASHER, PLAIN L 4	
12	S20577001	1	ウワメスオサエ	UPPER KNIFE PRESSER	
13	S20578101	1	ウワメスオサエイタ	UPPER KNIFE PRESSER PLATE	
14	025030132	1	ヒラザガネシヨウ3	WASHER, PLAIN S 3	
15-2	S20897101	1	カクメス幅狭 波刃	ANGLE KNIFE, NARROW WAVE EDGE	
16-2	062300412	1	ナベコ3X4	SCREW, PAN M3X4	
			<オプションパーツ>	<OPTION PARTS>	
15-2	S20896101	1	カクメス 幅狭	ANGLE KNIFE, NARROW	
15-2	S20579101	1	カクメス 幅広	ANGLE KNIFE, WIDE	
15-2	S20898101	1	カクメス 幅広 波刃	ANGLE KNIFE, WIDE WAVE EDGE	

H. 上ルーバ関係 / Over looper mechanism

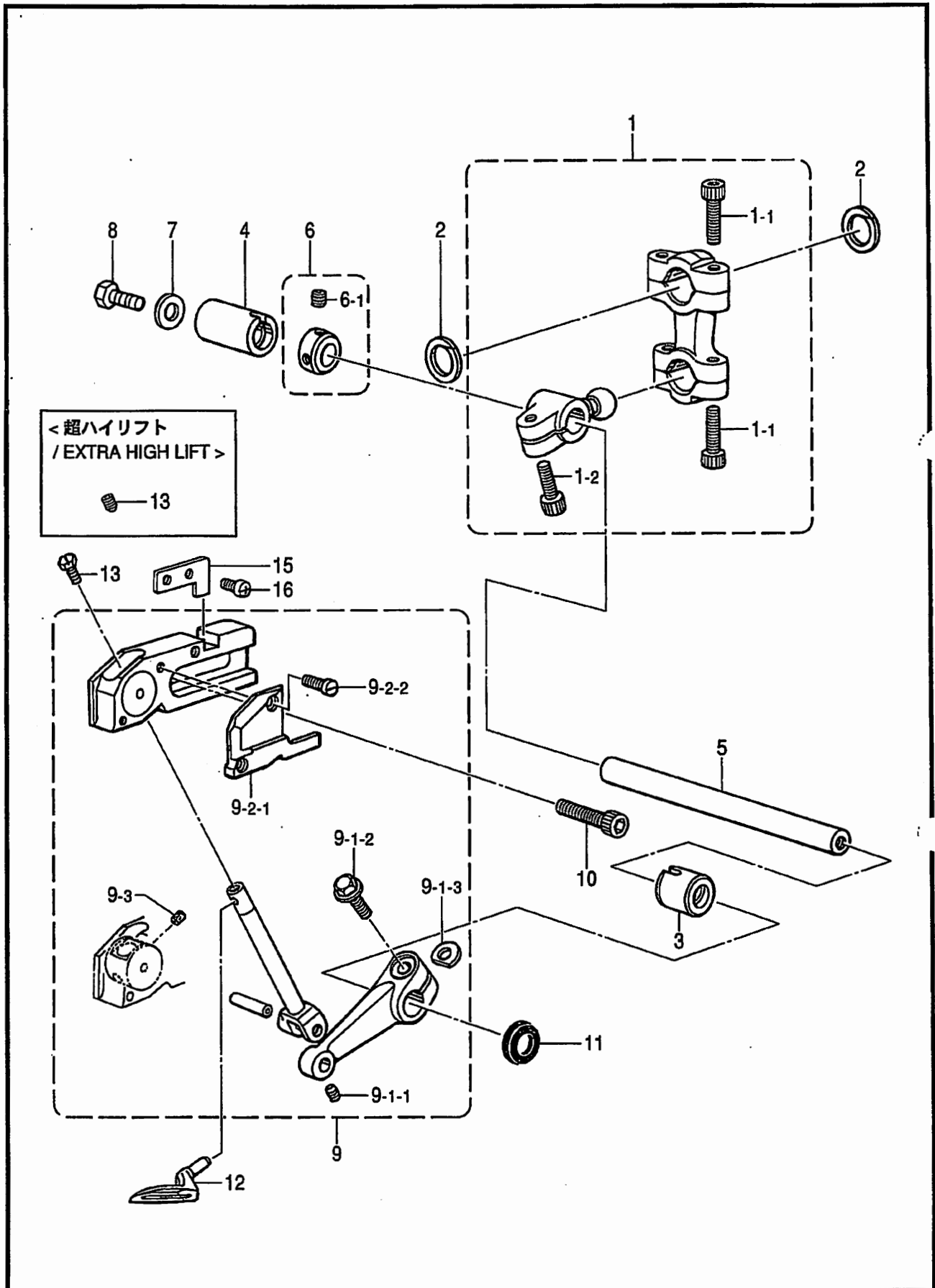

H. 上ルーパ関係 / Over looper mechanism

REF.NO.	CODE	QTY	ヒンメイ	NAME OF PARTS	RM
1	S46937001	1	<スタンダード用> ウワルーパロッドクミS	<FOR STANDARD> OVER LOOPER ROD ASSY, S	
1	S46940001	1	<ハイリフト、超ハイリフト用> ウワルーパロッドクミHE	<FOR HIGH LIFT & EXTRA HIGH LIFT> OVER LOOPER ROD ASSY, HE	
1-1	018401622	4	アナボルト4X16	BOLT, SOCKET M4X16	
1-2	S23346101	1	アナボルト6X14ホソメ	BOLT, SOCKET M6X14	
2	S20598000	2	ロッドフレドメ	ROD STOPPER	
3	S39728021	1	メタル11.11-18	BUSH, 11.11-18	
4	S39677021	1	メタル11.11-17	BUSH, 11.11-17	
5	S20601001	1	ウワルーパジク	OVER LOOPER SHAFT	
6	S23619001	1	セットカラークミ	SET SCREW COLLAR ASSY	
6-1	012060632	2	アナヒラ6X6	SET SCREW, SOCKET (FT) M6X6	
7	S23626001	1	ザガネ	WASHER	
8	017060812	1	ボルト6X8	BOLT, M6X8	
9	S46896001	1	<スタンダード、ハイリフト用> ウワルーパキコウクミSH	<FOR STANDARD & HIGH LIFT> OVER LOOPER MECHANISM ASSY, SH	
13	S46903001	1	アタマツキトメネジ4X5	SET SCREW, M4X5	
9	S46901001	1	<超ハイリフト用> ウワルーパキコウクミE	<FOR EXTRA HIGH LIFT> OVER LOOPER MECHANISM ASSY, E	
13	012400432	1	アナヒラ4X4	SET SCREW, SOCKET (FT) M4X4	
9-1-1	S23342001	1	アタトガリ4X5	SET SCREW, SOCKET (CN) M4X5	
9-1-2	S46899001	1	ザガネツキボルト6X16	BOLT, (S/P WASHER) M6X16	
9-1-3	155162001	1	スペーサ	SPACER	
9-2-1	S38320100	1	ウワルーパアンナイオサエ	OVER LOOPER GUIDE HOLDER	
9-2-2	S20355002	2	シメネジ3X8.5	SCREW, M3X8.5	
9-3	S29700000	2	ウワルーパアンナイフェルト	OVER LOOPER GUIDE FELT	
10	018061432	2	アナボルト6X14	BOLT, SOCKET M6X14	
11	155247000	1	ダストシール	DUST SEAL	
12	※	1	ウワルーパ	OVER LOOPER, A	
15	S23611101	1	アンナイメタルイテギメイタ	POTISIONING PLATE, GUIDE BUSH	
16	060400612	2	バインドM4X6	SCREW, BIND M4X6	

J. 下ルーパ関係 / Under looper mechanism

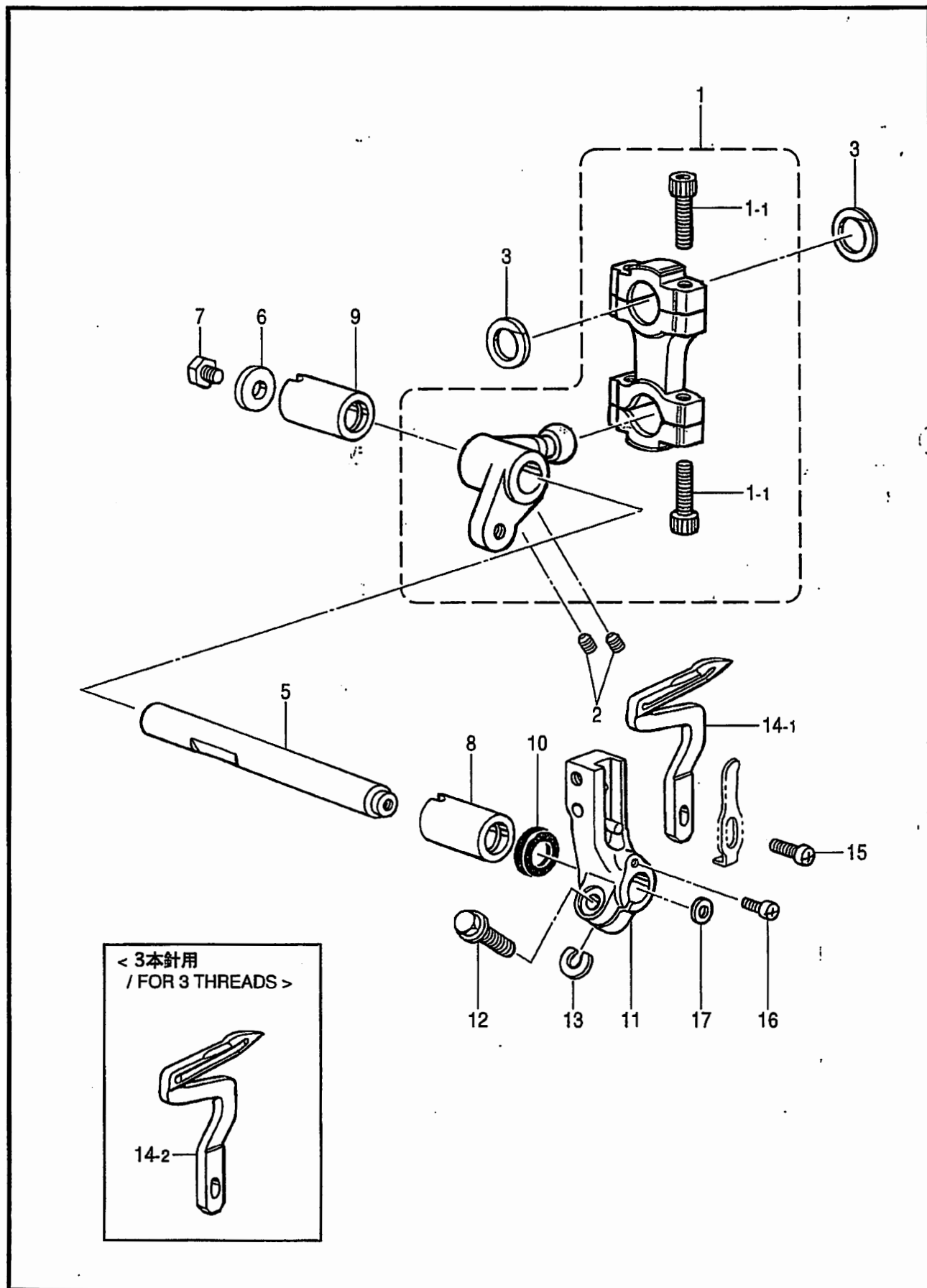

J. 下ルーパ関係 / Under looper mechanism

REF.NO.	CODE	Q'TY	ヒンメイ	NAME OF PARTS	RM
1	S46943001	1	<スタンダード、ハイリフト用> シタルーパロッドクミSH	<FOR STANDARD & HIGH LIFT> UNDER LOOPER ROD ASSY, I-SH	
1	S46944001	1	<超ハイリフト用> シタルーパロッドクミE	<FOR EXTRA HIGH LIFT> UNDER LOOPER ROD ASSY, I-E	
1-1	018401622	4	アナボルト4X16	BOLT, SOCKET M4X16	
2	012060632	2	アナヒラ6X6	SET SCREW, SOCKET (FT) M6X6	
3	S20598000	2	ロッドフレドメ	ROD STOPPER	
5	S46904001	1	シタルーパジク	UNDER LOOPER SHAFT	
6	S23626001	1	ザガネ	WASHER	
7	017060812	1	ボルト6X8	BOLT, M6X8	
8	S39728021	1	メタル11.11-18	BUSH, 11.11-18	
9	S39677021	1	メタル11.11-17	BUSH, 11.11-17	
10	155247000	1	ダストシール	DUST SEAL	
11	S20625151	1	シタルーパトリツケダイ	UNDER LOOPER HOLDER	
12	S23614101	1	フランジボルト5X14	BOLT, M5X14	
13	148782001	1	スペーサ	SPACER	
14-1	S20626001	1	シタルーパ	UNDER LOOPER	
15	060351012	1	バインド3.5X10	SCREW, BIND M3.5X10	
16	060350812	1	バインド3.5X8	SCREW, BIND M3.5X8	
17	158722002	1	ザガネ4.2	WASHER, PLAIN 4.2	
14-2	S20627001	1	<3本針用> シタルーパ	<FOR "3 THREADS"> UNDER LOOPER	

K. 二重環ルーパ関係 / Double chain stitch looper mechanism

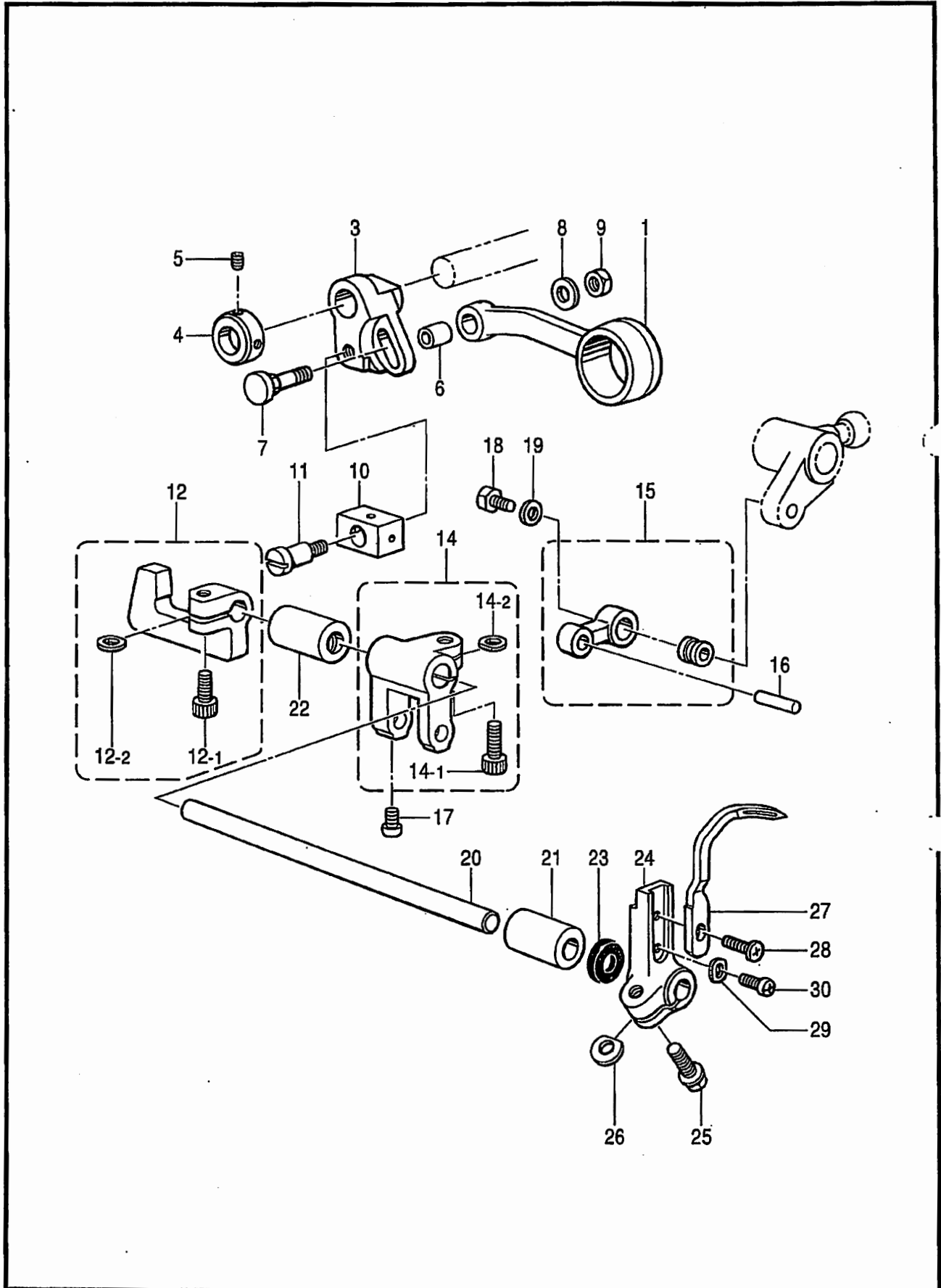

K. 二重環ルーバ関係 / Double chain stitch looper mechanism

REF.NO.	CODE	Q'TY	ヒンメイ	NAME OF PARTS	RM
1	S39729021	1	ゼンゴロツドクミ	LONGITUDINAL FEED ROD ASSY	
3	S39732021	1	ゼンゴウデ	LONGITUDINAL FEED ARM	
4	S39733001	1	セットカラー	SET SCREW COLLAR	
5	012400432	2	アナヒラ4X4	SET SCREW, SOCKET (FT) M4X4	
6	S29102001	1	ゼンゴロツドブツシュ	LONGITUDINAL FEED ROD BUSH	
7	S39734021	1	ゼンゴウデネジ	LONGITUDINAL FEED SCREW	
8	S39690021	1	ザガネ	WASHER	
9	021500216	1	2シユナツト5	NUT, 2 M5	
10	S20640001	1	ゼンゴウデカクゴマ	LONGITUDINAL FEED ARM SLIDE BLOCK	
11	S20641001	1	ダンネジ5	SHOULDER SCREW 5	
12	S31881101	1	カクゴマダキネジツキ	SLIDE BLOCK HOLDER	
12-1	018061432	1	アナホルト6X14	BOLT, SOCKET M6X14	
12-2	155162001	1	スペーサ	SPACER	
14	S44935001	1	ニジユウカンウデクミ	D-CHAIN STITCH LOOPER LEVER ASSY	
14-1	018061432	1	アナホルト6X14	BOLT, SOCKET M6X14	
14-2	155162001	1	スペーサ	SPACER	
15	S44937001	1	ニジユウカンリンククミ	D-CHAIN STITCH LOOPER LINK ASSY	
16	S44939001	1	ニジユウカンウデジク	D-CHAIN STITCH LOOPER LEVER PIN	
17	062300612	1	ナベコ3X6	SCREW, PAN M3X6	
18	S23360001	1	ボルト5X15	BOLT, M5X15	
19	S39690021	1	ザガネ	WASHER	
20	S20649051	1	ゼンゴジク	LONGITUDINAL FEED SHAFT	
21	S39741021	1	ゼンゴジクメタルF	LONGITUDINAL FEED SHAFT BUSH, F	
22	S39742021	1	ゼンゴジクメタルB	LONGITUDINAL FEED SHAFT BUSH, B	
23	155261000	1	ダストシール	DUST SEAL	
24	S20652001	1	ニジユウカンルーバホルダ	D-CHAIN STITCH LOOPER HOLDER	
25	S23614101	1	フランジボルト5X14	BOLT, M5X14	
26	148782001	1	スペーサ	SPACER	
27	S20653001	1	ニジユウカンルーバ	D-CHAIN STITCH LOOPER	
28	060350812	1	バインド35X8	SCREW, BIND M3.5X8	
29	S20654001	1	ルーバチヨウセツザガネ	WASHER	
30	S23456101	1	ナベコ25X6	SCREW, PAN M2.5X6	

L. 給油潤滑關係 / Lubrication

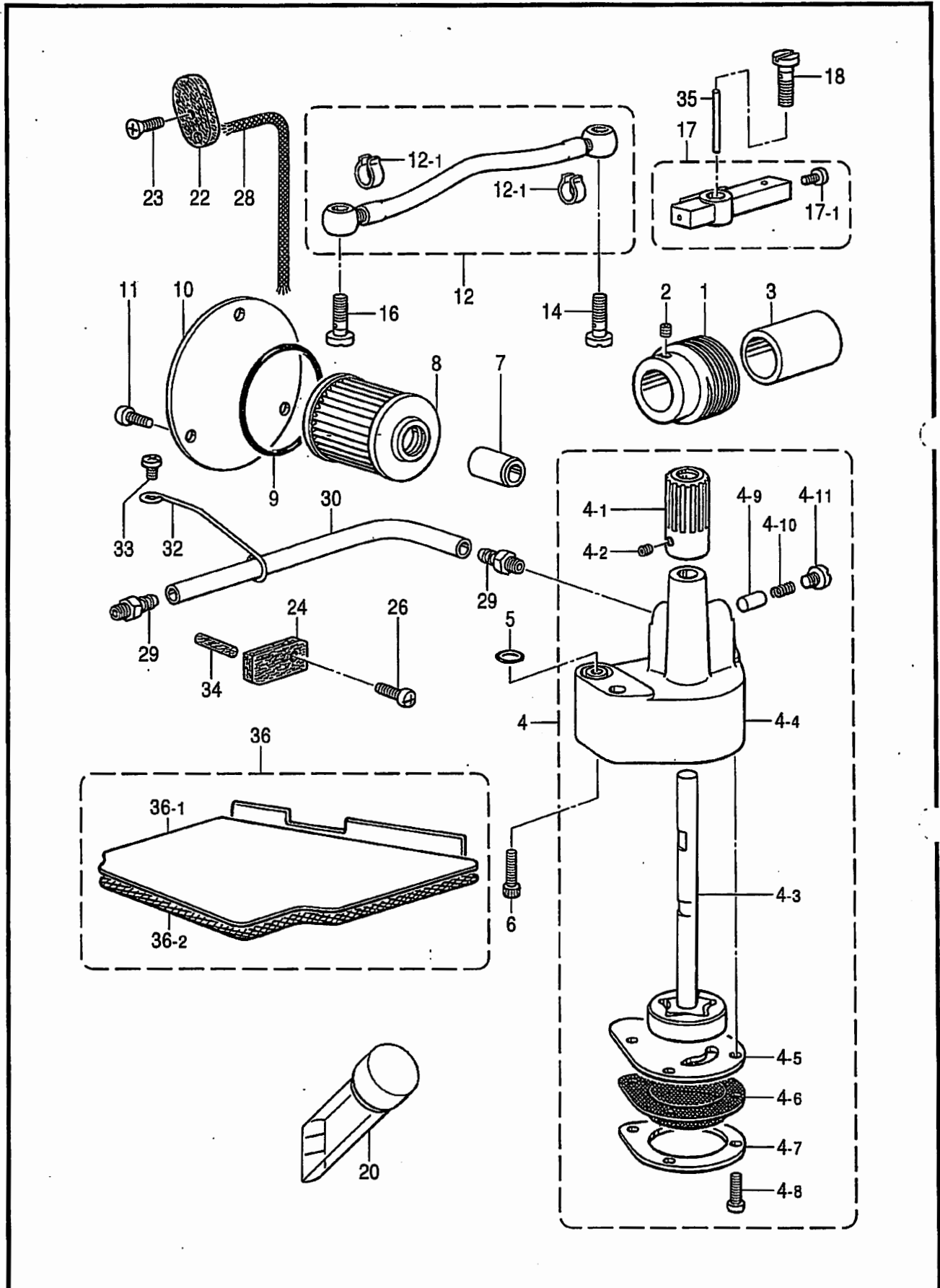

L. 給油潤滑関係 / Lubrication

REF.NO.	CODE	Q'TY	ヒンメイ	NAME OF PARTS	RM
1	S20655101	1	ウオーム	WORM	
2	012500536	2	アナヒラ5X5	SET SCREW, SOCKET (FT) M5X5	
3	S23366001	1	カラー	COLLAR	
4	S20656101	1	トロコイドポンプクミ	PUMP ASSY	
4-1	S20657001	1	ウオームホイール	WORM WHEEL	
4-2	012400536	2	アナヒラ4X5	SET SCREW, SOCKET (FT) M4X5	
4-3	S20658001	1	ポンプロータークミ	PUMP INNER ROTER ASSY	
4-4	S20660000	1	ポンプケース	PUMP CASE	
4-5	S20661000	1	ポンプタイフタ	CAP, PUMP BODY	
4-6	S20662100	1	ロカモウ	OIL FILTER	
4-7	S20663000	1	ロカモウオサエ	FILTER SUPPORT	
4-8	062351016	4	ナベコ3.5X10	SCREW, PAN M3.5X10	
4-9	144875001	1	プランジヤー	PLUNGER	
4-10	144876001	1	プランジヤーバネ	SPRING	
4-11	S23460001	1	ナベコ6X5	SCREW, PAN M6X5	
5	081008070	1	OリングP8	O RING, P8	
6	018061432	2	アナホルト6X14	BOLT, SOCKET M6X14	
7	S08957001	1	オイルクチ	OIL FEEDING PIPE	
8	S08956100	1	オイルフィルター	OIL FILTER	
9	081044070	1	OリングP44	O RING, P44	
10	S12987002	1	オイルフィルターフタ	CAP, OIL FILTER	
11	060400812	3	バインドM4X8	SCREW, BIND M4X8	
12	S46905001	1	ビニルチューブクミ	OIL TUBE ASSY	
12-1	147942001	2	ビニルチューブトメガネ	STOP RING	
14	S20199001	1	ハイユパイプツギテ	OIL PIPE JOINT	
16	S20199001	1	ハイユパイプツギテ	OIL PIPE JOINT	
17	S20666001	1	キユウユパイプクミ	OIL PIPE ASSY	
17-1	060400512	1	バインドM4X5	SCREW, BIND M4X5	
18	S20199001	1	ハイユパイプツギテ	OIL PIPE JOINT	
20	148084001	1	オイルゲージマド	OIL GAUGE WINDOW	
22	S20668100	1	ハリボウリンクフェルト	NEEDLE BAR LINK FELT	
23	061400812	1	サラコM4X8	SCREW, FLAT M4X8	
24	S20669000	1	フェルト	FELT	
26	060400812	1	バインドM4X8	SCREW, BIND M4X8	
28	S20671000	1	クミヒモ100	WICK, L = 100	
29	S20180001	2	オイルクチ	OIL FEEDING PIPE	
30	S20200001	1	ビニルチューブ	OIL TUBE, L = 370	
32	S25879001	1	チューブササエ	TUBE SUPPORT	
33	060400812	1	バインドM4X8	SCREW, BIND M4X8	
34	S20392000	1	フェルト	FELT	
35	S25526000	1	ピン	PIN	
36	S43523000	1	フィルタークミ	FILTER ASSY	
36-1	S43522000	1	オイルフィルター	OIL FILTER	
36-2	S43521000	1	ロカモウD	FILTER, D	

M.糸調子関係 / Thread tension

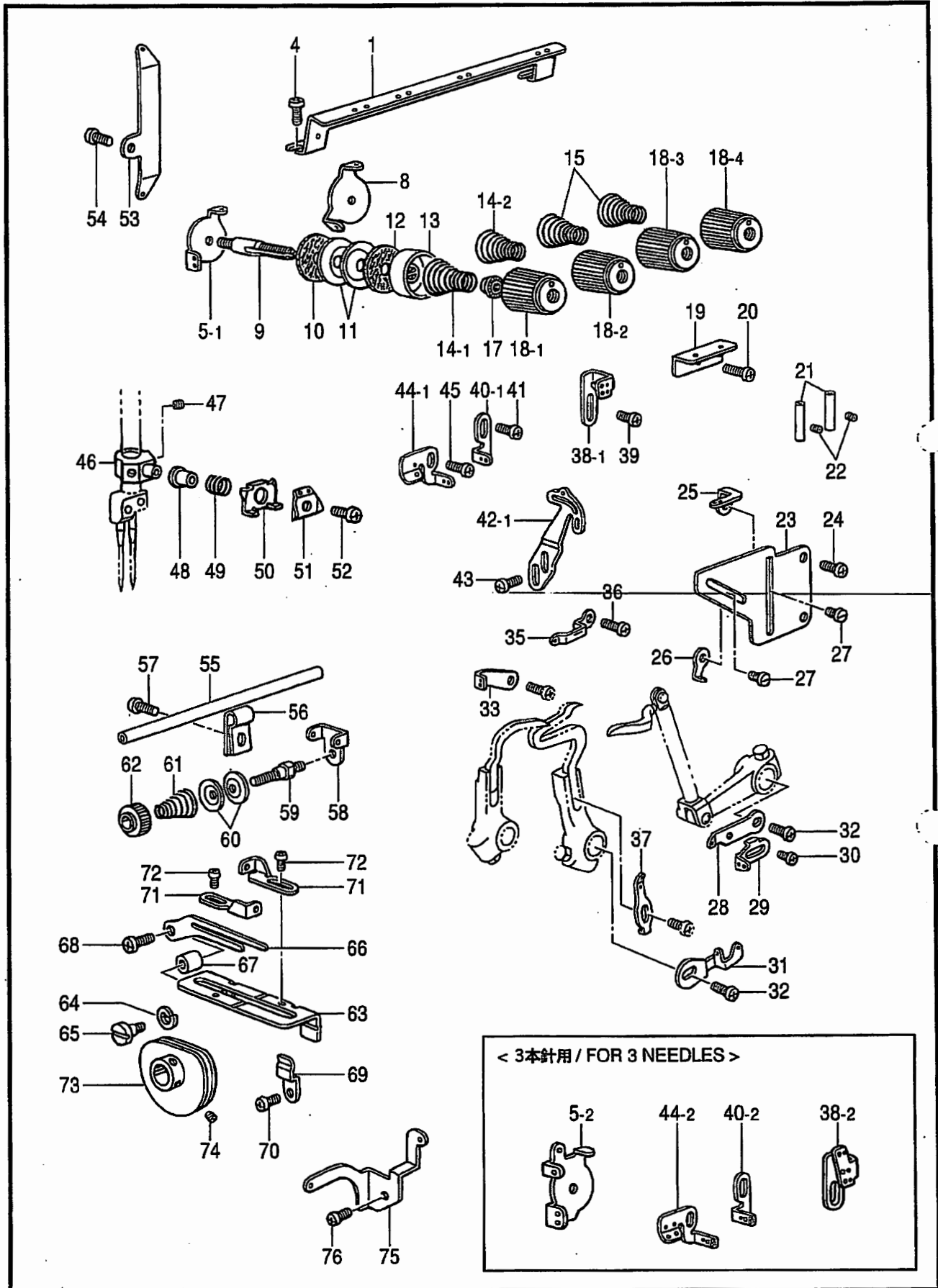

M.糸調子関係 / Thread tension

REF.NO.	CODE	QTY	ヒンメイ	NAME OF PARTS	RM
1	S20672001	1	シユイトアンナイ	MAIN THREAD GUIDE	
4	060400812	2	バインドM4X8	SCREW, BIND M4X8	
5-1	S20693001	1	ハリイトアンナイ2N	NEEDLE GUIDE, 2-NEEDLE	
8	S20675001	3	チヨウシサライトアンナイ	TENSION DISC THREAD GUIDE	
9	S20676051	4	イトチヨウシボウ	TENSION STUD	
10	S20677000	4	イトチヨウシサラフェルト	TENSION DISC FELT	
11	S20673001	8	イトチヨウシサラ	TENSION DISC	
12	110832009	4	イトチヨウシサラフェルト	TENSION DISC FELT	
13	144103009	4	イトチヨウシサラオサエ	TENSION DISC PRESSER	
14-1	S20678001	1	イトチヨウシバネL	TENSION SPRING, L	
14-2	S32276001	1	イトチヨウシバネLL	TENSION SPRING, LL	
15	S20679001	2	イトチヨウシバネM	TENSION SPRING, M	
17	S20681000	4	チヨウシバネウエザガネ	WASHER	
18-1	S20682103	1	イトチヨウシナツト(赤)	TENSION NUT, RED	
18-2	S20682101	1	イトチヨウシナツト(水色)	TENSION NUT, LIGHT BLUE	
18-3	S20682104	1	イトチヨウシナツト(黄)	TENSION NUT, YELLOW	
18-4	S20682102	1	イトチヨウシナツト(緑)	TENSION NUT, GREEN	
19	S20683001	1	ルーバイトアンナイ	LOOPER THREAD GUIDE	
20	060400812	1	バインドM4X8	SCREW, BIND M4X8	
21	146592001	2	イトアンナイパイプ	THREAD GUIDE PIPE	
22	S23452002	2	アナヒラ4X3.2	SET SCREW, SOCKET (FT) M4X3.2	
23	S20684101	1	イトアンナイドガイ	THREAD GUIDE BRACKET	
24	060400612	2	バインドM4X6	SCREW, BIND M4X6	
25	S20685001	1	シタルーバイトアンナイR	UNDER LOOPER THREAD GUIDE, R	
26	S20686001	1	ウワルーバイトアンナイR	OVER LOOPER THREAD GUIDE, R	
27	S23418002	2	シメネジ4X5	SCREW, M4X5	
28	S21133001	1	ウワルーパテンビンR	OVER LOOPER THREAD TAKE-UP, R	
29	S21134001	1	シタルーパテンビンR	UNDER LOOPER THREAD TAKE-UP, R	
30	060300412	1	バインドM3X4	SCREW, BIND M3X4	
31	S21135001	1	ルーパテンビンL	LOOPER THREAD TAKE-UP, L	
32	060400612	2	バインドM4X6	SCREW, BIND M4X6	
33	S21137001	1	ルーバイトアンナイM1	LOOPER THREAD GUIDE, M1	
35	S21136101	1	ウワルーバイトアンナイL	OVER LOOPER THREAD GUIDE, L	
36	060400612	1	バインドM4X6	SCREW, BIND M4X6	
37	S20687001	1	シタルーバイトアンナイL	UNDER LOOPER THREAD GUIDE, L	
38-1	S21127001	1	ハリイトアンナイC	NEEDLE THREAD GUIDE, C	
39	060400612	1	バインドM4X6	SCREW, BIND M4X6	
40-1	S21126001	1	ハリイトアンナイB	NEEDLE THREAD GUIDE, B	
41	060400612	1	バインドM4X6	SCREW, BIND M4X6	
42-1	S21130051	1	ハリイトテンビンA	NEEDLE THREAD TAKE-UP, A	
43	060400812	2	バインドM4X8	SCREW, BIND M4X8	
44-1	S21125001	1	ハリイトアンナイA	NEEDLE THREAD GUIDE, A	
45	060400612	1	バインドM4X6	SCREW, BIND M4X6	
46	S38330050	1	ハリイトオサエホルダー	NEEDLE THREAD PRESSER HOLDER	
47	146427001	2	アナトメネジ3.18クボミ	SET SCREW, SOCKET (CP) SM3.18	
48	S20689001	1	ハリイトオサエカラー	NEEDLE THREAD PRESSER COLLAR	
49	S20690001	1	ハリイトオサエバネ	SPRING	
50	S20691001	1	ハリイトオサエイタ	NEEDLE THREAD PRESSER PLATE	
51	S20743001	1	ハリイトアンナイ	NEEDLE THREAD GUIDE	
52	060300612	1	バインドM3X6	SCREW, BIND M3X6	
53	S20694001	1	ルーバイトアンナイ	LOOPER THREAD GUIDE	
54	060400612	1	バインドM4X6	SCREW, BIND M4X6	
55	S20695001	1	DLイトアンナイパイプ	THREAD GUIDE PIPE	
56	S20696001	1	イトアンナイパイプササエ	THREAD GUIDE PIPE SUPPORT	
57	060400612	1	バインドM4X6	SCREW, BIND M4X6	
58	S20697001	1	DLチヨウシサライトアンナイ	LOOPER THREAD GUIDE	
59	S20698121	1	イトチヨウシボウ	TENSION STUD	
60	144504001	2	イトアンナイサラ	THREAD GUIDE DISC	
61	158782101	1	プレテンションバネ	PRE TENSION SPRING	

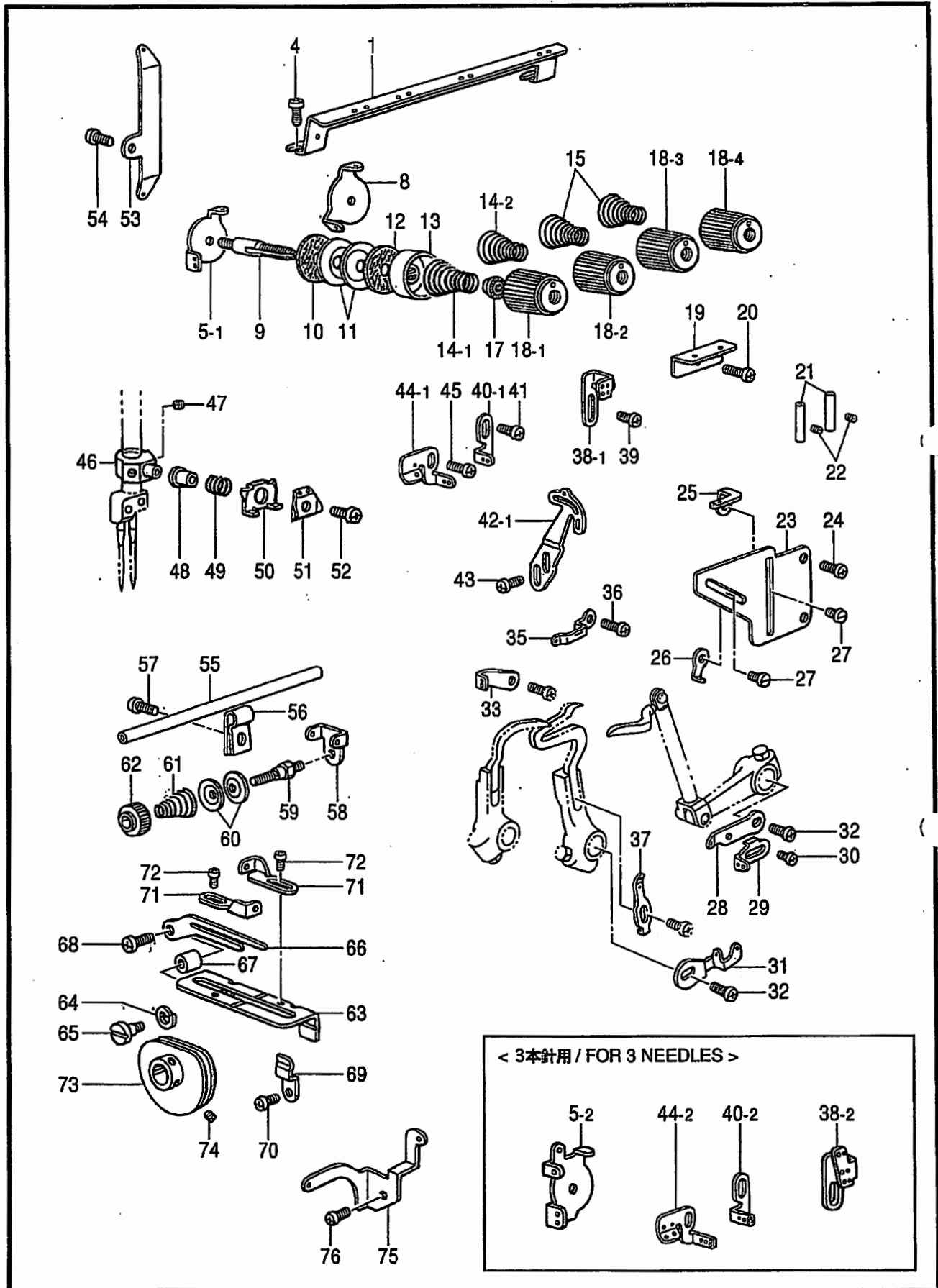

M. 糸調子関係 / Thread tension

REF.NO.	CODE	Q'TY	ヒンメイ	NAME OF PARTS	RM
62	155510001	1	イトチヨウシナツト	TENSION NUT	
63	S39756021	1	イトサバキドダイ	THREAD HANDLER BRACKET	
64	028050242	1	バネザガネ2-5	WASHER, SPRING 2-5	
65	S20342001	1	ダンネジ4	SHOULDER SCREW, M4	
66	S20701001	1	テンビンイトサバキ	THREAD HANDLER	
67	S39757001	1	カラー	COLLAR	
68	060401412	1	バインドM4X14	SCREW, BIND M4X14	
69	150813001	1	ドダイオサエバネ	SPRING	
70	062350612	1	ナベコM3.5X6	SCREW, PAN M3.5X6	
71	S20702001	2	DLテンビンイトアンナイ	THREAD TAKE-UP GUIDE	
72	S20158101	2	ナベコ25X3	SCREW, PAN M2.5X3	
73	S20703051	1	DLテンビンクミ	THREAD TAKE-UP ASSY	
74	S23452002	2	アナヒラ4X3.2	SET SCREW, SOCKET (FT) M4X3.2	
75	S20707001	1	DLイトアンナイA	CHAIN STITCH THREAD GUIDE	
76	060400612	1	バインドM4X6	SCREW, BIND M4X6	
<3本針用>				<FOR "3 NEEDLES">	
5-2	S30121001	1	ハリイトアンナイ3N	NEEDLE GUIDE, 3-NEEDLE	
38-2	S30122001	1	ハリイトアンナイC	NEEDLE THREAD GUIDE, C 3-NEED.	
40-2	S21129001	1	ハリイトアンナイB	NEEDLE THREAD GUIDE, B	
44-2	S21128001	1	ハリイトアンナイA	NEEDLE THREAD GUIDE, A	

P. 針冷却関係 / Needle cooler

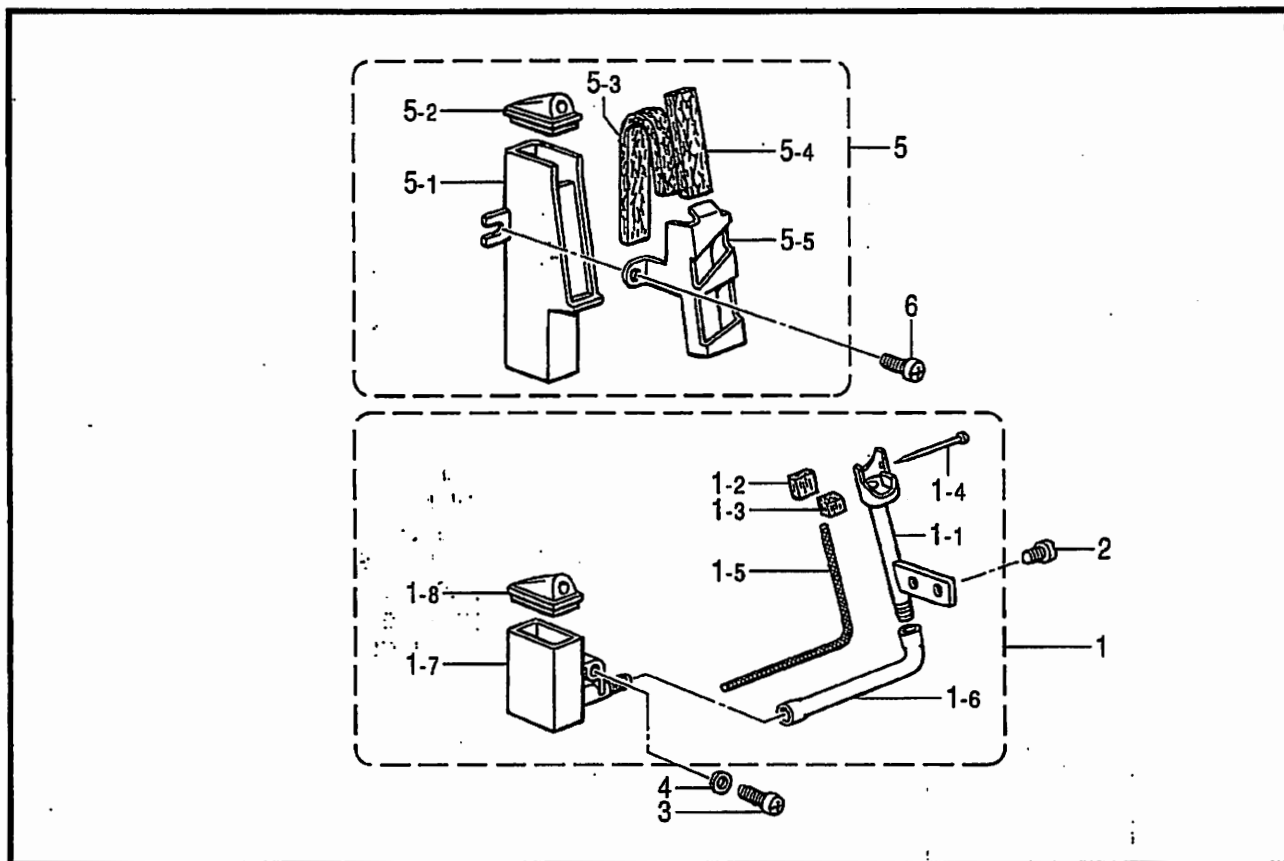

878-V6A-124

Q. 縁カガリ定規関係 / Serging attachment

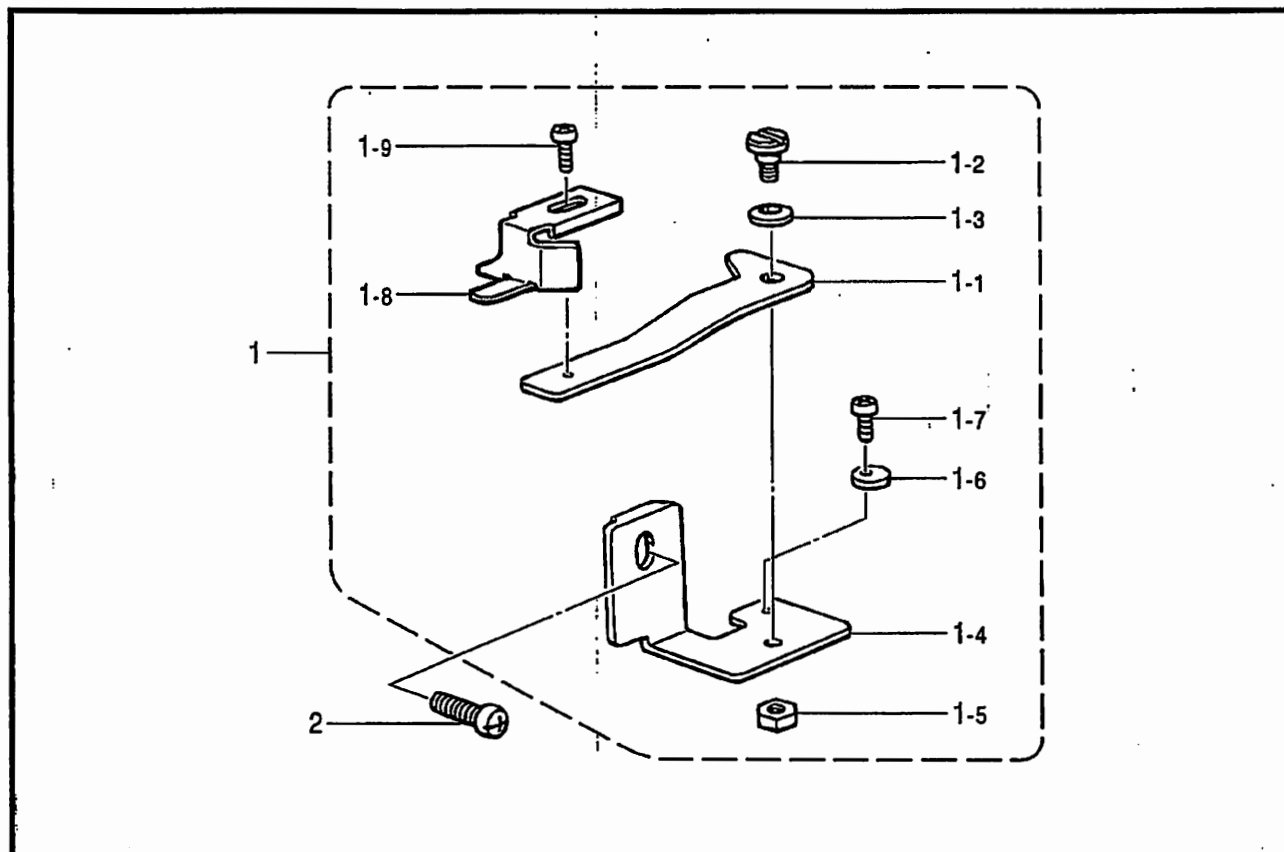

878-V6A-236

P. 針冷却関係 / Needle cooler

REF.NO.	CODE	Q'TY	ヒンメイ	NAME OF PARTS	RM
1	S20468001	1	フェルトササエクミ	FELT SUPPORT ASSY	
1-1	S20469000	1	フェルトササエ	FELT SUPPORT	
1-2	S20470000	1	フェルトL	FELT, L	
1-3	S20471000	1	フェルトS	FELT, S	
1-4	S02874001	1	ムシピン	PIN	
1-5	150307000	1	クミヒモ	WICK, L= 140	
1-6	S20456000	1	ビニルチューブ55	VINYL TUBE, 55	
1-7	S20459000	1	シリコンタンクタイL	SILICONE TANK, L	
1-8	S20460000	1	シリコンタンクフタ	CAP, SILICONE TANK	
2	S23418002	2	シメネジ4X5	SCREW, M4X5	
3	060401012	1	バインドM4X10	SCREW, BIND M4X10	
4	025040132	1	ヒラザガネシヨウ4	WASHER, PLAIN S 4	
5	S20461101	1	シリコンタンククミU	SILICONE TANK ASSY, U	
5-1	S20464000	1	シリコンタンクU	SILICONE TANK, U	
5-2	S20460000	1	シリコンタンクフタ	CAP, SILICONE TANK	
5-3	S29933000	1	フェルトL	FELT, L	
5-4	S29934000	1	フェルトS	FELT, S	
5-5	S20467001	1	フェルトオサエイタ	FELT SUPPORT PLATE	
6	062401012	1	ナベコM4X10	SCREW, PAN M4X10	

878-V6A-124

Q. 縁カガリ定規関係 / Serging attachment

REF.NO.	CODE	Q'TY	ヒンメイ	NAME OF PARTS	RM
1	S32140001	1	フチカガリジヨウギクミ	EDGE GUIDE ASSY	
1-1	S23896101	1	ジヨウギトリツケイタ	EDGE GUIDE SET PLATE	
1-2	S23773001	1	ダンネジ4	SHOULDER SCREW, M4	
1-3	146598001	1	バネザガネ	WASHER, SPRING	
1-4	S23897001	1	ジヨウギトリツケイタササエ	EDGE GUIDE SUPPORT	
1-5	021400212	1	2シユナツト4	NUT, 2 M4	
1-6	S21341001	1	ストツパー	STOPPER	
1-7	062300512	1	ナベコ3X5	SCREW, PAN M3X5	
1-8	146600001	1	フチカガリジヨウギ	EDGE GUIDE	
1-9	062350612	1	ナベコM3.5X6	SCREW, PAN M3.5X6	
2	062401012	1	ナベコM4X10	SCREW, PAN M4X10	

878-V6A-236

R. ラフラー装置関係 / Ruffling attachment

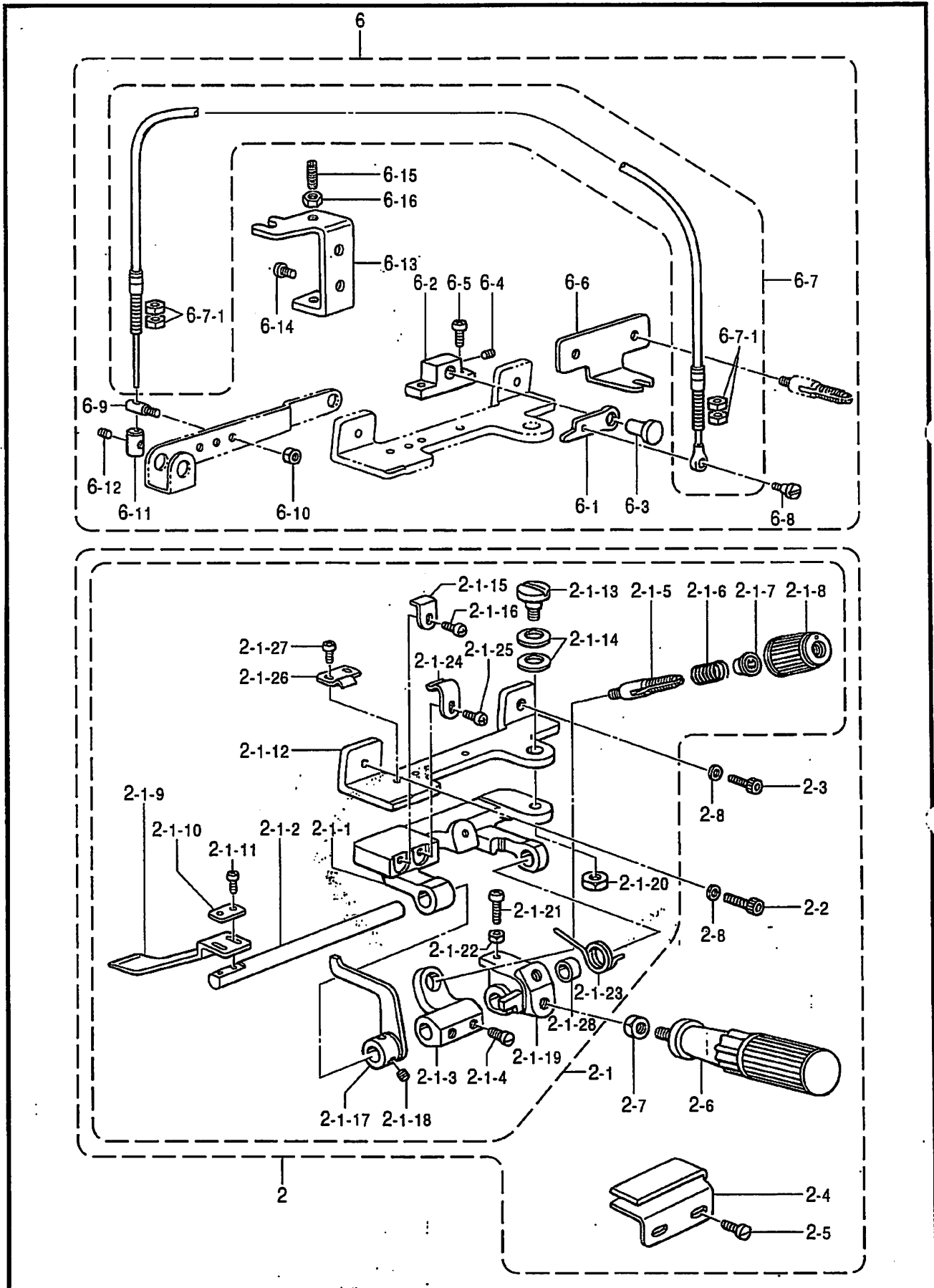

R. ラフラー装置関係 / Ruffling attachment

REF.NO.	CODE	Q'TY	ヒンメイ	NAME OF PARTS	RM
2	S30304001	1	ラフラークミ	RUFFLER PARTS SET	
2-1	S21293001	1	ラフラーソウチクミ	RUFFLER ATTACHMENT ASSY	
2-1-1	S21294001	1	キジオサエタイ	RUFFLING BLADE BRACKET	
2-1-2	S21295001	1	キジオサエトリツケジク	RUFFLING BLADE BASE SHAFT	
2-1-3	S21305001	1	バネウケ	SPRING BASE	
2-1-4	S23777101	2	アタマツキトメネジ6	SET SCREW, M6	
2-1-5	S20676051	1	イトチヨウシボウ	TENSION STUD	
2-1-6	S23775001	1	コイルバネ	SPRING, COIL	
2-1-7	S20681000	1	チヨウシバネウエザガネ	WASHER	
2-1-8	S20682105	1	イトチヨウシナツト	TENSION NUT	
2-1-9	S21296001	1	キジオサエ	RUFFLING BLADE	
2-1-10	144784001	1	キジオサエザガネ	WASHER	
2-1-11	062300812	2	ナベコ3X8	SCREW, PAN M3X8	
2-1-12	S21297001	1	ラフラーソウチトリツケダイ	RUFFLER BASE	
2-1-13	S21306001	1	ダンネジ6	SHOULDER SCREW, M6	
2-1-14	S21307001	2	バネザガネ	WASHER, SPRING	
2-1-15	S21298001	1	キジオサエアンナイ	RUFFLING BLADE GUIDE	
2-1-16	062400812	1	ナベコ4X8	SCREW, PAN M4X8	
2-1-17	S21299001	1	キジオサエアゲ	CLOTH PRESSER BAR LIFTER	
2-1-18	S23651002	2	アナヒラ6X6ホソメ	SET SCREW, SOCKET (FT) M6X5"	
2-1-19	S21300001	1	ハンドルトリツケイタ	HANDLE SETTING PLATE	
2-1-20	021060302	1	ナツト3シユ6	NUT, 3 M6	
2-1-21	062401612	1	ナベコM4X16	SCREW, PAN M4X16	
2-1-22	021400212	1	2シユナツト4	NUT, 2 M4	
2-1-23	S21301001	1	ハンドルモドシバネ	SPRING	
2-1-24	S21302001	1	キジオサエタイトメバネU	SPRING, PLATE (U)	
2-1-25	062400612	1	ナベコM4X6	SCREW, PAN M4X6	
2-1-26	S21303001	1	キジオサエタイトメバネD	SPRING, PLATE (D)	
2-1-27	062350512	2	ナベコ3.5X5	SCREW, PAN M3.5X5	
2-1-28	S21304001	1	カラー	COLLAR	
2-2	018401632	1	アナボルトM4X16	BOLT, SOCKET M4X16	
2-3	018401032	1	アナボルト4X10	BOLT, SOCKET M4X10	
2-4	S21590000	1	キジオアンナイ	RUFFLER GUIDE	
2-5	S23418002	2	シメネジ4X5	SCREW, M4X5	
2-6	S23779001	1	ハンドル	HANDLE	
2-7	021060302	1	ナツト3シユ6	NUT, 3 M6	
2-8	102707002	2	ザガネ	WASHER, PLAIN 4	
6	S30137011	1	ラフラーオサエレンドウクミ	RUFFLING DEVICE SET	
6-1	S21310001	1	キジオサエアゲ	CLOTH PRESSER BAR LIFTER LEVER	
6-2	S21311001	1	オサエアゲダイ	PRESSER BAR LIFTER BRACKET	
6-3	S21312001	1	ピン6.35	PIN, 6.35	
6-4	012060632	1	アナヒラ6X6	SET SCREW, SOCKET (FT) M6X6	
6-5	062350812	2	ナベコ3.5X8	SCREW, PAN M3.5X8	
6-6	S21313001	1	ワイヤートリツケイタ	WIRE SET PLATE	
6-7	S21314001	1	フレキシブルワイヤークミ	FLEXIBLE WIRE ASSY	
6-7-1	021500303	4	ナツト3シユ5	NUT, 3 M5	
6-8	S23774001	1	ダンネジ3.5	SHOULDER SCREW, M3.5	
6-9	S21315001	1	スタツドM4	STUD, M4	
6-10	021400212	1	2シユナツト4	NUT, 2 M4	
6-11	S21316001	1	ワイヤーストツパー	WIRE STOPPER	
6-12	012400432	1	アナヒラ4X4	SET SCREW, SOCKET (FT) M4X4	
6-13	S23349001	1	レバーチヨウセツイタ	LEVER ADJUSTING PLATE	
6-14	060400812	2	バインドM4X8	SCREW, BIND M4X8	
6-15	011502012	2	トメネジ5X20ヒラ	SET SCREW, (FT) M5X20	
6-16	021500312	2	3シユナツト5	NUT, 3 M5	

< 半沈用 / FOR SEMI-SUBMERGED >

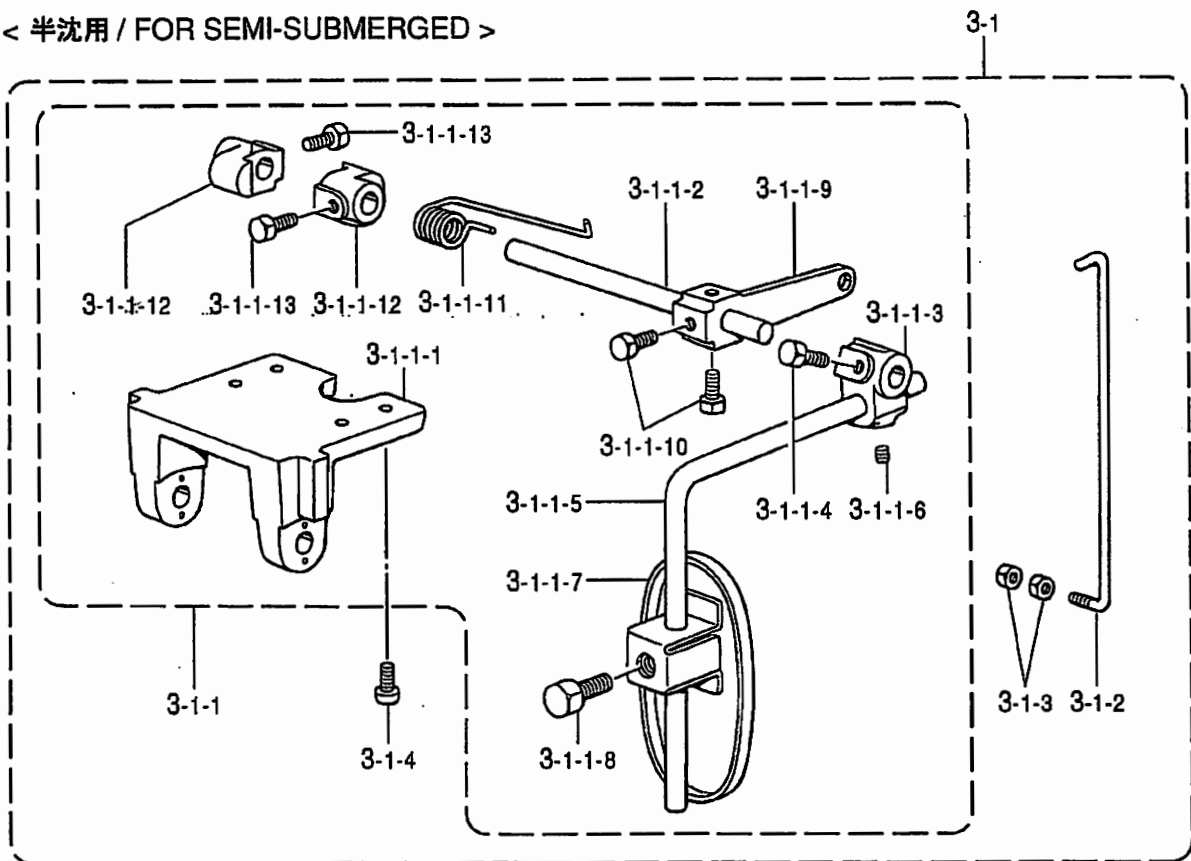

< 全沈用 / FOR FULL-SUBMERGED >

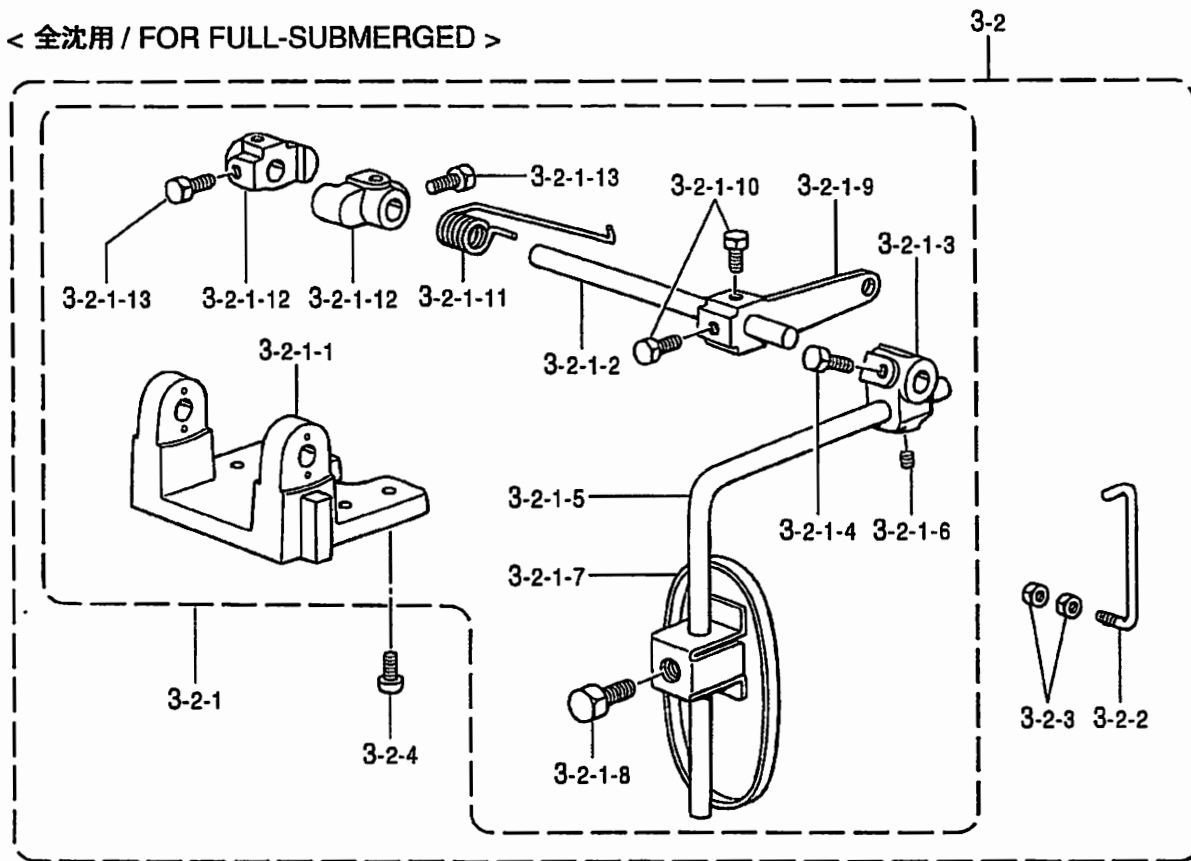

R. ラフラー装置関係 / Ruffling attachment

REF.NO.	CODE	Q'TY	ヒンメイ	NAME OF PARTS	RM
			<半沈用>	< FOR SEMI-SUBMERGED >	
3-1	S30135101	1	サドウチヨウセツセット	DIFFERENTIAL ADJUSTING SET	
3-1-1	S21373101	1	サドウチヨウセツクミ	DIFFERENTIAL FEED ADJUSTER	
3-1-1-1	155197101	1	ヒザアテヨコジクウケ	KNEE LIFTER SHAFT BRACKET	
3-1-1-2	S21375001	1	ヨコジク	KNEE LIFTER SHAET	
3-1-1-3	155199101	1	ヒザアテツギテ	KNEE LIFTER BRACKET	
3-1-1-4	017781012	2	ボルト6.35X10	BOLT, SM6.35X10	
3-1-1-5	148797001	1	ヒザアゲタテジクS	KNEE LIFTER BAR, S	
3-1-1-6	014780622	1	アナトメネジ6.35クボミ	SET SCREW, SOCKET (CP) SM6.35	
3-1-1-7	148798109	1	ヒザアテL	KNEE LIFTER PLATE, L	
3-1-1-8	017081606	1	ボルト8X16	BOLT, M8X16	
3-1-1-9	S21376001	1	ヒザアテレバー	KNEE LIFTER LEVER	
3-1-1-10	017781012	2	ボルト6.35X10	BOLT, SM6.35X10	
3-1-1-11	S21377001	1	ヒザアテレバーバネ	SPRING	
3-1-1-12	S21378001	2	ヨコジクトメグ	COLLAR	
3-1-1-13	017781012	4	ボルト6.35X10	BOLT, SM6.35X10	
3-1-2	S21379001	1	ヒザアテリンク	CONNECTING BAR	
3-1-3	021400202	2	2シユナツト4	NUT, 2 M4	
3-1-4	062401012	4	ナベコM4X10	SCREW, PAN M4X10	
			<全沈用>	< FOR FULL-SUBMERGED >	
3-2	S30135102	1	サドウチヨウセツセット	DIF. ADJUSTING SET, FULL	
3-2-1	S21380101	1	サドウチヨウセツソウチクミ	DIFFERENTIAL FEED ADJUSTER	
3-2-1-1	155197101	1	ヒザアテヨコジクウケ	KNEE LIFTER SHAFT BRACKET	
3-2-1-2	S21375001	1	ヨコジク	KNEE LIFTER SHAET	
3-2-1-3	155199101	1	ヒザアテツギテ	KNEE LIFTER BRACKET	
3-2-1-4	017781012	2	ボルト6.35X10	BOLT, SM6.35X10	
3-2-1-5	148797001	1	ヒザアゲタテジクS	KNEE LIFTER BAR, S	
3-2-1-6	014780622	1	アナトメネジ6.35クボミ	SET SCREW, SOCKET (CP) SM6.35	
3-2-1-7	148798109	1	ヒザアテL	KNEE LIFTER PLATE, L	
3-2-1-8	017081606	1	ボルト8X16	BOLT, M8X16	
3-2-1-9	S21376001	1	ヒザアテレバー	KNEE LIFTER LEVER	
3-2-1-10	017781012	2	ボルト6.35X10	BOLT, SM6.35X10	
3-2-1-11	S21377001	1	ヒザアテレバーバネ	SPRING	
3-2-1-12	S21378001	2	ヨコジクトメグ	COLLAR	
3-2-1-13	017781012	4	ボルト6.35X10	BOLT, SM6.35X10	
3-2-2	S21381001	1	ヒザアテリンク	CONNECTING BAR	
3-2-3	021400202	2	2シユナツト4	NUT, 2 M4	
3-2-4	062401012	4	ナベコM4X10	SCREW, PAN M4X10	

R: ラフラー装置関係 / Ruffling attachment

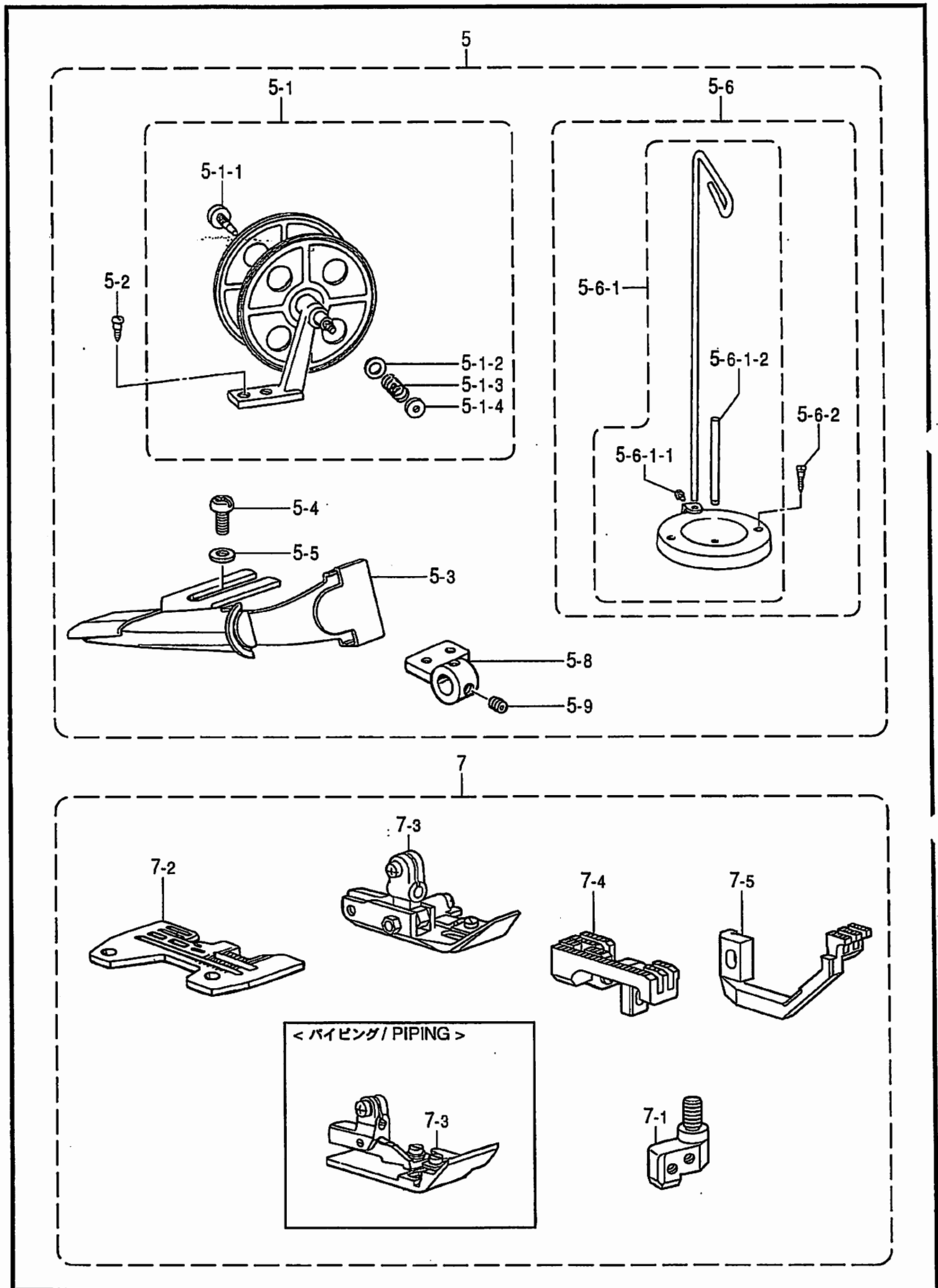

R. ラフラー装置関係 / Ruffling attachment

REF.NO.	CODE	Q'TY	ヒンメイ	NAME OF PARTS	RM
5	S30303001	1	パイピングパーツクミ	PIPING PARTS ASSY	
5-1	143767002	1	テープワインダークミ	TAPE WINDER ASSY	
5-1-1	143980001	1	ツマミネジ	SCREW	
5-1-2	108494001	1	ザガネ	WASHER	
5-1-3	108495001	1	テープワインダオシバネ	SPRING	
5-1-4	100136001	1	イドチヨウシナツト	TENSION NUT	
5-2	101118001	2	マルモクネジ4.5X20	WOOD SCREW, ROUND M4.5X20	
5-3	S21318000	1	ラツパークミ	LAPPER ASSY	
5-4	062400812	2	ナベコ4X8	SCREW, PAN M4X8	
5-5	025040232	2	ヒラザガネテユウ4	WASHER, PLAIN M 4	
5-6-1	S20131009	1	イトタテダイクミ	COTTON STAND ASSY	
5-6-1-1	S20134001	1	シメネジW476-24X10	SCREW, W4.76-24X10	
5-6-1-2	S20135001	1	イトタテボウ	SPOOL PIN	
5-6-2	034422006	2	+2サラモク41X20	WOOD SCREW, FLAT 2 M4.1X20	
5-8	S25019001	1	ラツパードダイ	LAPPER BASE	
5-9	S23651002	2	アナヒラ6X6ホソメ	SET SCREW, SOCKET (FT) M6X5	
7		1	ラフラーゲージクミ	RUFFLER GAUGE ASSY	
			<パイピング用>	< FOR PIPING >	
7		1	P.ラフラーゲージクミ	PIPING RUFFLER GAUGE ASSY	
7-1	※	1	ハリドメクミ	NEEDLE GAUGE ASSY	
7-2	※	1	ハリイタ	NEEDLE PLATE	
7-3	※	1	オサエクミ	PRESSER FOOT ASSY	
7-4	※	1	シエオクリバクミ	MAIN FEED DOG ASSY	
7-5	※	1	サドウオクリバ	DIFFERENTIAL FEED DOG	

REF.NO.	4420-24,5420		4420-25,5420		4420-34,5420	
	半沈 Semi- Submerged	全沈 Full- Submerged	半沈 Semi- Submerged	全沈 Full- Submerged	半沈 Semi- Submerged	全沈 Full- Submerged
ラフラーショウセット/RUFFLER SET	S30298201	S31109201	S30298202	S31109202	S30298203	S31109203
ラフラーゲージクミ/RUFFLER GAUGE ASSY	7	—	S30296002	—	S30296003	—
ラフラークミ/RUFFLER ASSY	2	—	—	—	—	—
サドウチョウセツセット/DIFFERENTIAL ADJUSTING SET	3	S30135101	S30135102	S30135101	S30135102	S30135101
ラフラーオサエレンドウクミ/RUFFLING DEVICE SET	6	S30137011	—	—	—	—

REF.NO.	4420-35,5420		4430-55,5430		4430-56,5430	
	半沈 Semi- Submerged	全沈 Full- Submerged	半沈 Semi- Submerged	全沈 Full- Submerged	半沈 Semi- Submerged	全沈 Full- Submerged
ラフラーショウセット/RUFFLER SET	S30298204	S31109204	S30298205	S31109205	S30298206	S31109206
ラフラーゲージクミ/RUFFLER GAUGE ASSY	7	S30296004	—	S30296005	—	S30296006
ラフラークミ/RUFFLER ASSY	2	S30304001	—	—	—	—
サドウチョウセツセット/DIFFERENTIAL ADJUSTING SET	3	S30135101	S30135102	S30135101	S30135102	S30135101
ラフラーオサエレンドウクミ/RUFFLING DEVICE SET	6	S30137011	—	—	—	—

REF.NO.	4620-35,5620		4630-55,5630		4630-56,5630	
	半沈 Semi- Submerged	全沈 Full- Submerged	半沈 Semi- Submerged	全沈 Full- Submerged	半沈 Semi- Submerged	全沈 Full- Submerged
P. ラフラーショウセット/PIPING RUFFLER SET	S30299204	S31110204	S30299205	S31110205	S30299206	S31110206
P. ラフラーゲージクミ/PIPING RUFFLER GAUGE ASSY	7	S30297004	—	S30297005	—	S30297006
ラフラークミ/RUFFLER ASSY	2	S30304001	—	—	—	—
サドウチョウセツセット/DIFFERENTIAL ADJUSTING SET	3	S30135101	S30135102	S30135101	S30135102	S30135101
パイピングパーツクミ/PIPING PARTS ASSY	5	S30303001	—	—	—	—
ラフラーオサエレンドウクミ/RUFFLING DEVICE SET	6	S30137011	—	—	—	—

T. ラッパ-関係 / Lapper mechanism

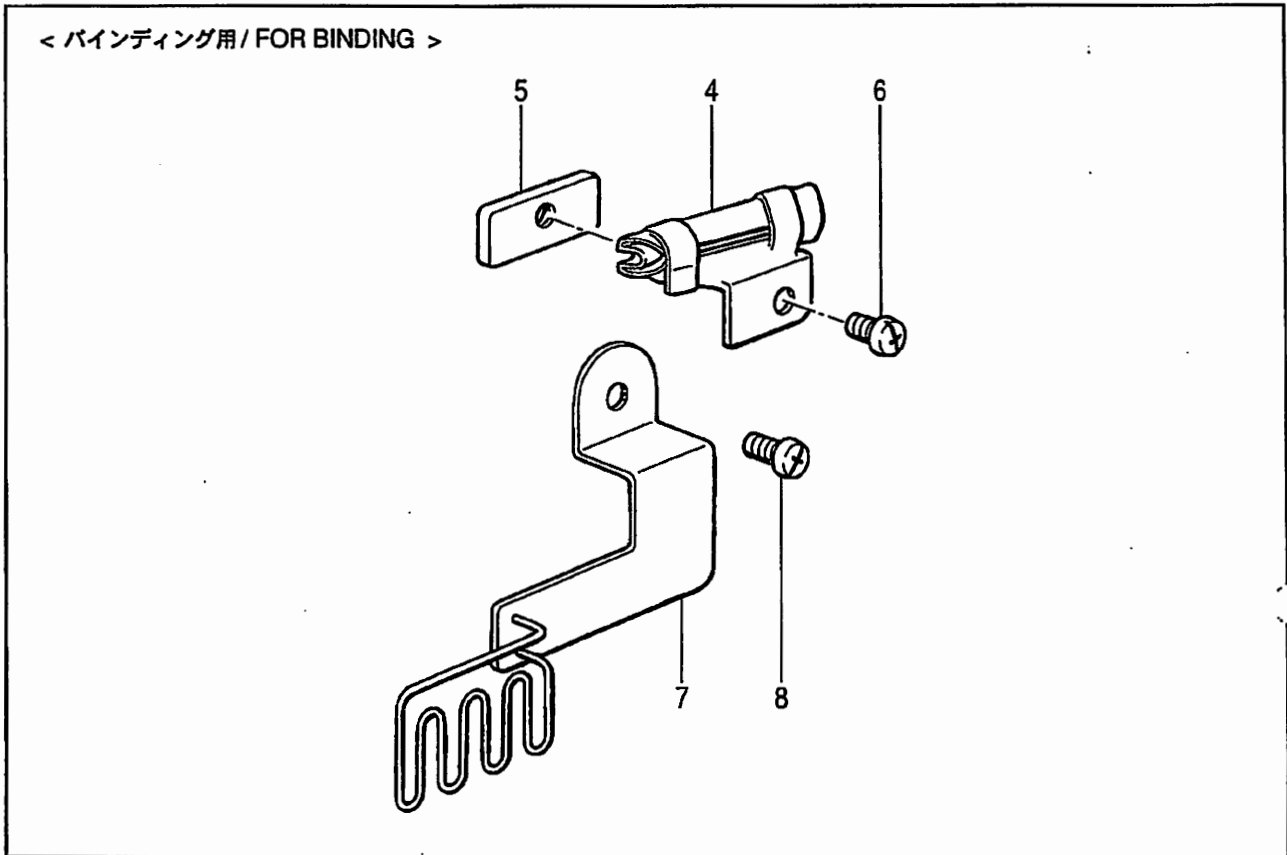

878-V6A-239

T. ラッパ-関係 / Lapper mechanism

REF.NO.	CODE	Q'TY	ヒンメイ	NAME OF PARTS	RM
			<バインディング用>	< FOR BINDING >	
4	529824000	1	ラッパ-8クミ(テープ幅8mm用)	LAPPER ASSY, 8 (FOR TAPE WIDTHS 8mm)	
4	529827000	1	ラッパ-10クミ(テープ幅10mm用)	LAPPER ASSY, 10 (FOR TAPE WIDTHS 10mm)	
5	529835001	1	ラッパ-アンナイイタ	LAPPER GUIDE PLATE	
6	523418002	1	シメネジ4X5	SCREW, M4X5	
7	529831000	1	テープアンナイクミ	LAPPER GUIDE ASSY	
8	060400612	1	バインドM4X6	SCREW, BIND M4X6	

878-V6A-239

Z. 付属品関係 / Accessories

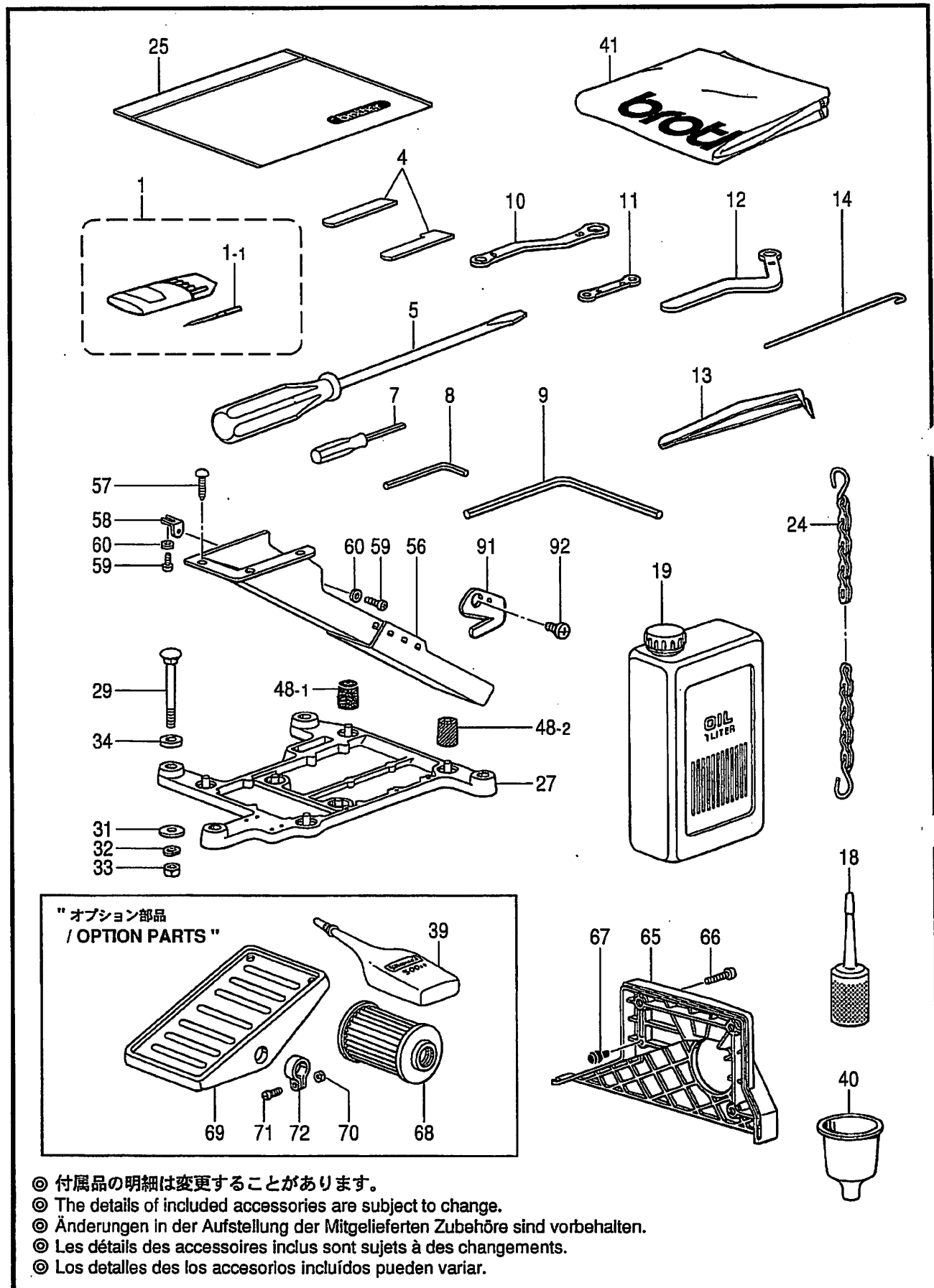

- ◎ 付属品の明細は変更することがあります。
- ◎ The details of included accessories are subject to change.
- ◎ Änderungen in der Aufstellung der Mitgelieferten Zubehöre sind vorbehalten.
- ◎ Les détails des accessoires inclus sont sujets à des changements.
- ◎ Los detalles de los accesorios incluidos pueden variar.

Z. 付属品関係 / Accessories

REF.NO.	CODE	Q'TY	ヒンメイ	NAME OF PARTS	RM
1		2	ミシンハリクミ	NEEDLE ASSY, DCX27	
1-1	※	8	ミシンハリ	NEEDLE, DCX27	
4	※	1	シタメス	LOWER KNIFE, T = 1.5	
5	101572101	1	ネジマワシ5.5X190	SCREW DRIVER, 5.5X190	
7	S01943001	1	6カクボウネジマワシ1.6	SCREW DRIVER, HEX. 1.6	
8	142002001	1	6カクボウスパナ2	HEXAGONAL WRENCH, 2	
9	149570001	1	6カクボウスパナ5	HEXAGONAL WRENCH, 5	
10	S23356001	1	メガネレンチ8X10	DOUBLE WRENCH, 8X10	
11	S46907001	1	メガネレンチ5X6	DOUBLE WRENCH, 5X6	
12	S20723001	1	メガネレンチ8	WRENCH, 8	
13	117466000	1	ピンセット	PINCETTE	
14	S24473000	1	イトトオシ	THREADER	
18	S06701000	1	ポリオイラークミ	POLY OILER ASSY	
19	145277205	1	オイルタンク	OIL TANK	
24	142262001	1	クサリフクミ	CHAIN, F ASSY	
25	122991001	1	フゾクヒンポリフクロ	ACCESSORY BAG	
27	S20718000	1	トウブウケ	HEAD PLATE	
29	S35997001	4	カクネボルト8X85	BOLT, M8X85	
31	213650001	4	ワ2.3X8.5X38ST	WASHER, 2.3X8.5X38ST	
32	028080242	4	バネザガネ2-8	WASHER, SPRING 2-8	
33	021080106	4	ナット1シユ8	NUT, 1 M8	
34	S20719000	4	クツシヨン	CUSHION	
39	S06704001	1	シリコンオイル	-----	
40	S20769000	1	ジヨーゴ	FUNNEL	
41	144225002	1	トウブカバー	HEAD COVER	
48-1	147919051	1	ボウシンゴム	RUBBER CUSHION	
48-2	147919052	3	ボウシンゴム	RUBBER CUSHION	
56	183797009	1	ダスターシユートクミ	DUSTER CHUTE ASSY	
57	031411304	3	マルモクネジ4.1X13	WOOD SCREW, ROUND M4.1X13	
58	S23353001	1	ダスターシユートササエS	DUSTER SHOOT SUPPORT, S	
59	062400612	2	ナベコM4X6	SCREW, PAN M4X6	
60	025040332	2	ヒラザガネダイ4	WASHER, PLAIN L 4	
65	S38645001	1	ベルトカバークミ	BELT COVER ASSY	
66	062061412	3	ナベコ6X14	SCREW, PAN M6X14	
67	S20412000	1	ゴムセン3.7	RUBBER CAP, 3.7	
68	S08956100	1	オイルフィルター	-----	
69	147893009	1	オサエアゲフミイタ	-----	
70	021400106	2	ナット1シユ4	-----	
71	062401406	2	ナベコ4X14	-----	
72	116016001	2	ペタルトメ	-----	
91	S20118151	1	カラヌイメス	TRIMMING KNIFE	
92	060300512	1	バインドM3X5	SCREW, BIND M3X5	
				<OPTION PARTS>	
39	S06704001	1	-----	SILICONE OIL	
68	S08956100	1	-----	OIL FILTER	
69	147893009	1	-----	TREADLE PEDAL	
70	021400106	2	-----	NUT, 1 M4	
71	062401406	2	-----	SCREW, PAN M4X14	
72	116016001	2	-----	PEDAL STOPPER	

Z. 付属品関係 / Accessories

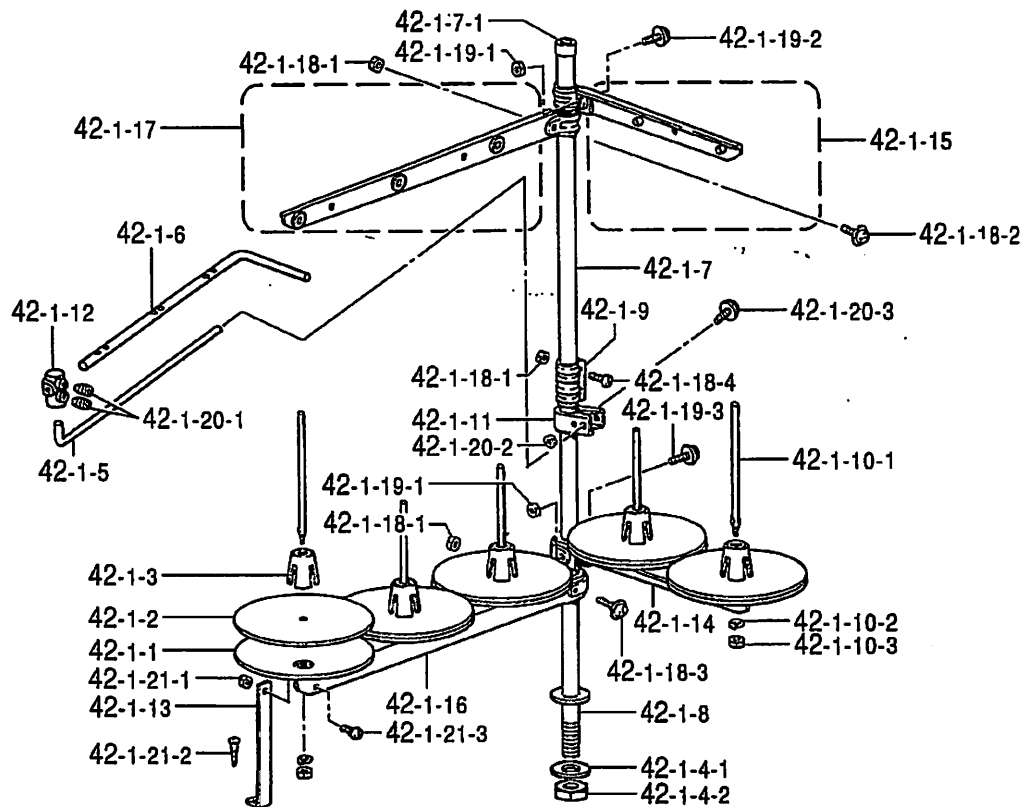

オプション部品 / OPTION PARTS

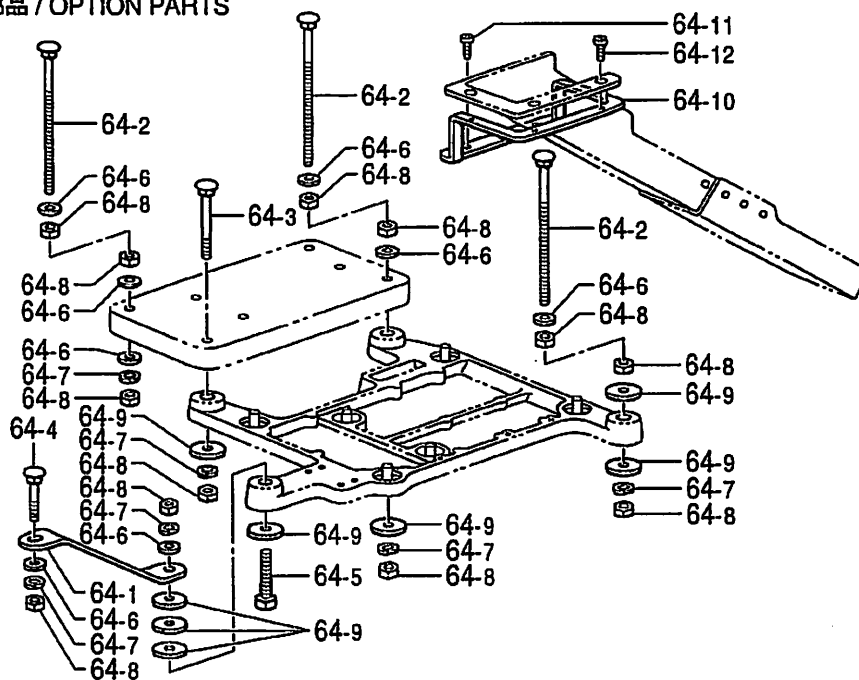

- ◎ 付属品の明細は変更することがあります。
- ◎ The details of included accessories are subject to change.
- ◎ Änderungen in der Aufstellung der Mitgelieferten Zubehöre sind vorbehalten.
- ◎ Les détails des accessoires inclus sont sujets à des changements.
- ◎ Los detalles de los accesorios incluidos pueden variar.

Z. 付属品関係 / Accessories

REF.NO.	CODE	QTY	ヒンメイ	NAME OF PARTS	RM
42-1	S29855109	1	イトタテダイクミ5DTHF	COTTON STAND ASSY, 5DTHF	
42-1-1	150180001	5	ウケザラ	SPOOL STAND BASE	
42-1-2	150182000	5	スプールマット	SPOOL MAT	
42-1-3	126863001	5	スプールクッション	SPOOL CUSHION	
42-1-4	S02775001	1	パイプネジセットA	PIPE SCREW SET, A	
42-1-4-1	150206002	1	ヒラザガネ16	WASHER, PLAIN 16	
42-1-4-2	S38648001	1	6カクナツトU5/8	NUT, U5/8-28	
42-1-5	S04109001	1	イトアンナイササエボウ	THREAD GUIDE SUPPORT BAR	
42-1-6	142999101	1	イトアンナイ5	THREAD GUIDE, 5	
42-1-7	S40640001	1	コラムパイプキャップツキ	COLUMN PIPE WITH CAP	
42-1-7-1	150174000	1	コラムキャップ	COLUMN CAP	
42-1-8	156112003	1	コラムパイプD	COLUMN PIPE, D	
42-1-9	150173003	1	コラムジョイント	COLUMN JOINT	
42-1-10	S21798001	5	スプールネジセット	SPOOL SCREW SET	
42-1-10-1	150179002	5	スプールジクB	SPOOL SHAFT, B	
42-1-10-2	028050246	5	バネザガネ2-5	WASHER, SPRING 2-5	
42-1-10-3	021500106	5	1シユナツト5	NUT, 1 M5	
42-1-11	150185009	1	イトアンナイホルダー	THREAD GUIDE HOLDER	
42-1-12	138843001	1	ササエボウツギテ	JOINT	
42-1-13	150188009	1	スプールホルダーササエA	SPOOL HOLDER SUPPORT, A	
42-1-14	S02778002	1	スプールホルダー2	SPOOL HOLDER, 2	
42-1-15	S02786002	1	スレツドハンガークミ2	THREAD HANGER ASSY, 2	
42-1-16	S02779009	1	スプールホルダー3	SPOOL HOLDER, 3	
42-1-17	S02788009	1	スレツドハンガークミ3	THREAD HANGER ASSY, 3	
42-1-18	S40641001	1	スプールジクネジセットA	SPOOL SCREW SET, A	
42-1-18-1	021500106	4	1シユナツト5	NUT, 1 M5	
42-1-18-2	S37038001	1	ナベコヒラザ5X14	SCREW, PAN (S/P WASHER) M5X14	
42-1-18-3	S37037001	1	ナベコヒラザ5X32	SCREW, PAN (S/P WASHER) M5X32	
42-1-18-4	062501406	2	ナベコ5X14	SCREW, PAN M5X14	
42-1-19	S40642001	1	スプールジクネジセットB	SPOOL SHAFT SCREW SET, B	
42-1-19-1	021500106	2	1シユナツト5	NUT, 1 M5	
42-1-19-2	S37038001	1	ナベコヒラザ5X14	SCREW, PAN (S/P WASHER) M5X14	
42-1-19-3	S37037001	1	ナベコヒラザ5X32	SCREW, PAN (S/P WASHER) M5X32	
42-1-20	S40643001	1	ホルダーツギテネジセット	HOLDER JOINT SCREW SET	
42-1-20-1	014060632	2	アナトメ6X6クボミ	SET SCREW, SOCKET (CP) M6X6	
42-1-20-2	021500106	1	1シユナツト5	NUT, 1 M5	
42-1-20-3	S37037001	1	ナベコヒラザ5X32	SCREW, PAN (S/P WASHER) M5X32	
42-1-21	S40644001	1	ホルダーツギテネジセット	HOLDER JOINT SCREW SET	
42-1-21-1	021500106	1	1シユナツト5	NUT, 1 M5	
42-1-21-2	031452206	1	マルモク45X22	WOOD SCREW, ROUND M4.5X22	
42-1-21-3	062501006	1	ナベコ5X10	SCREW, PAN M5X10	
64	183798001	1	フルサブマージセット	FULL SUBMERGED SET	
64-1	S20721001	1	トウブウケササエ	HEAD PLATE SUPPORT	
64-2	153318201	4	カクネマルアタマボルト	BOLT	
64-3	S35997001	1	カクネボルト8X85	BOLT, M8X85	
64-4	S36007001	1	カクネボルト8X55	BOLT, M8X55	
64-5	017085502	1	ボルトM8X55	BOLT, M8X55	
64-6	025080236	11	ヒラザガネチユウ8	WASHER, PLAIN M 8	
64-7	028080242	7	バネザガネ2-8	WASHER, SPRING 2-8	
64-8	021080106	15	ナツト1シユ8	NUT, 1 M8	
64-9	213650001	8	ワ2.3X8.5X385T	WASHER, 2.3X8.5X385T	
64-10	S20722001	1	ダスターシュートササエL	DUSTER SHOOT SUPPORT, L	
64-11	060400812	2	バインドM4X8	SCREW, BIND M4X8	
64-12	060400812	3	バインドM4X8	SCREW, BIND M4X8	

Z. 付属品関係 / Accessories

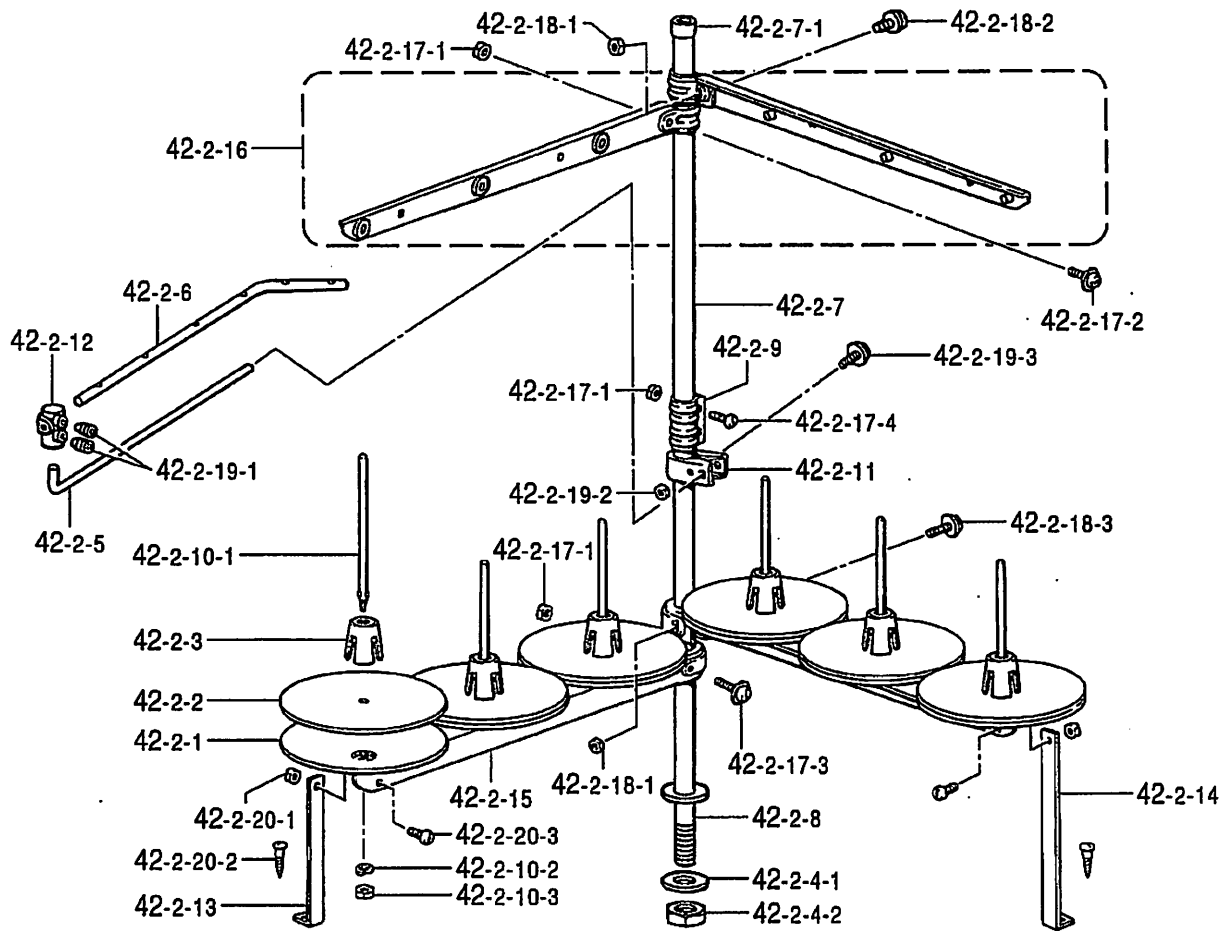









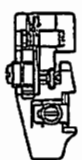
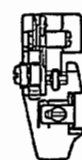
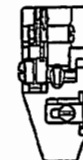
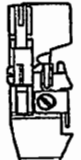
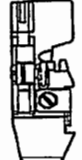
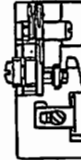



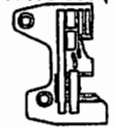
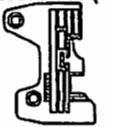

- ◎ 付属品の明細は変更することがあります。
- ◎ The details of included accessories are subject to change.
- ◎ Änderungen in der Aufstellung der Mitgelieferten Zubehöre sind vorbehalten.
- ◎ Les détails des accessoires inclus sont sujets à des changements.
- ◎ Los detalles de los accesorios incluidos pueden variar.

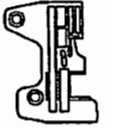
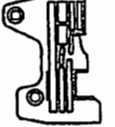
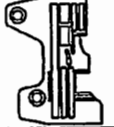
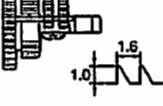
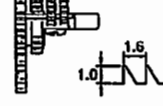
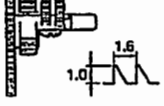
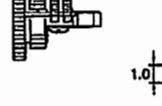
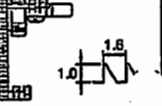
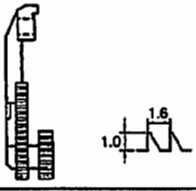
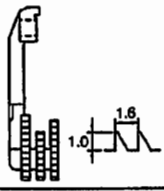
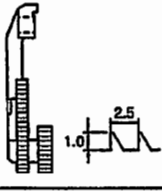
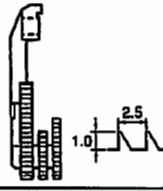
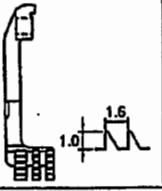



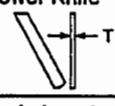







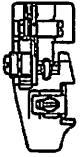

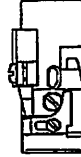
Z. 付属品関係 / Accessories

REF.NO.	CODE	QTY	ヒンメイ	NAME OF PARTS	RM
42-2	S29864109	1	イトタテダイクミ6DTHF	COTTON STAND ASSY, 6DTHF	
42-2-1	150180001	6	ウケザラ	SPOOL STAND BASE	
42-2-2	150182000	6	スプールのマット	SPOOL MAT	
42-2-3	126863001	6	スプールのクッション	SPOOL CUSHION	
42-2-4	S02775001	1	パイプネジセットA	PIPE SCREW SET, A	
42-2-4-1	150206002	1	ヒラザガネ16	WASHER, PLAIN 16	
42-2-4-2	S38648001	1	6カクナツトU5/8	NUT, U5/8-28	
42-2-5	S04109001	1	イトアンナイササエボウ	THREAD GUIDE SUPPORT BAR	
42-2-6	S02783001	1	イトアンナイ6	THREAD GUIDE, 6	
42-2-7	S40640001	1	コラムパイプキャップツキ	COLUMN PIPE WITH CAP	
42-2-7-1	150174000	1	コラムキャップ	COLUMN CAP	
42-2-8	156112003	1	コラムパイプD	COLUMN PIPE, D	
42-2-9	150173003	1	コラムジョイント	COLUMN JOINT	
42-2-10	S21798001	6	スプールのネジセット	SPOOL SCREW SET	
42-2-10-1	150179002	6	スプールのジクB	SPOOL SHAFT, B	
42-2-10-2	028050246	6	バネザガネ2-5	WASHER, SPRING 2-5	
42-2-10-3	021500106	6	1シユナツト5	NUT, 1 M5	
42-2-11	150185009	1	イトアンナイホルダー	THREAD GUIDE HOLDER	
42-2-12	138843001	1	ササエボウツギテ	JOINT	
42-2-13	150188009	1	スプールのホルダーササエA	SPOOL HOLDER SUPPORT, A	
42-2-14	150194009	1	スプールのホルダーササエB	SPOOL HOLDER SUPPORT, B	
42-2-15	S02779009	2	スプールのホルダー3	SPOOL HOLDER, 3	
42-2-16	S02788009	2	スレッドハンガークミ3	THREAD HANGER ASSY, 3	
42-2-17	S40641001	1	スプールのジクネジセットA	SPOOL SCREW SET, A	
42-2-17-1	021500106	4	1シユナツト5	NUT, 1 M5	
42-2-17-2	S37038001	1	ナベコヒラザ5X14	SCREW, PAN (S/P WASHER) M5X14	
42-2-17-3	S37037001	1	ナベコヒラザ5X32	SCREW, PAN (S/P WASHER) M5X32	
42-2-17-4	062501406	2	ナベコ5X14	SCREW, PAN M5X14	
42-2-18	S40642001	1	スプールのジクネジセットB	SPOOL SHAFT SCREW SET, B	
42-2-18-1	021500106	2	1シユナツト5	NUT, 1 M5	
42-2-18-2	S37038001	1	ナベコヒラザ5X14	SCREW, PAN (S/P WASHER) M5X14	
42-2-18-3	S37037001	1	ナベコヒラザ5X32	SCREW, PAN (S/P WASHER) M5X32	
42-2-19	S40643001	1	ホルダーツギテネジセット	HOLDER JOINT SCREW SET	
42-2-19-1	014060632	2	アナトメ6X6クボミ	SET SCREW, SOCKET (CP) M6X6	
42-2-19-2	021500106	1	1シユナツト5	NUT, 1 M5	
42-2-19-3	S37037001	1	ナベコヒラザ5X32	SCREW, PAN (S/P WASHER) M5X32	
42-2-20	S40644001	2	ホルダーツギテネジセット	HOLDER JOINT SCREW SET	
42-2-20-1	021500106	2	1シユナツト5	NUT, 1 M5	
42-2-20-2	031452206	2	マルモク45X22	WOOD SCREW, ROUND M4.5X22	
42-2-20-3	062501006	2	ナベコ5X10	SCREW, PAN M5X10	



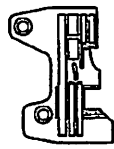
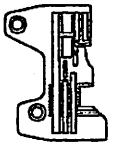
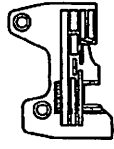
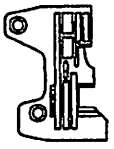
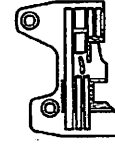
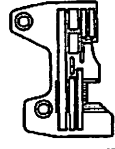
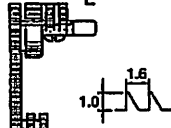
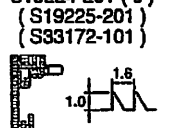
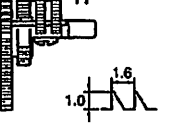
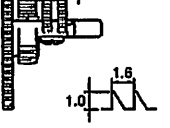
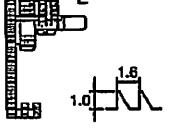
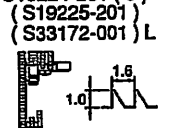
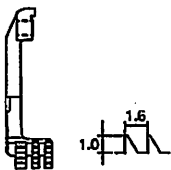
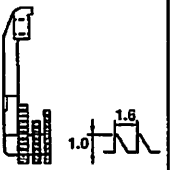
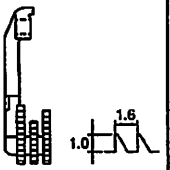
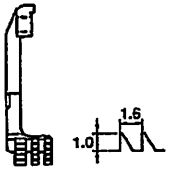

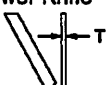





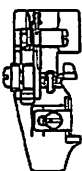
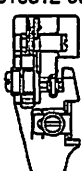

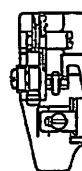
Ga1 . ゲージ部品一覧表 / Gauge parts List

用途 Application	一般地縫用 (薄) Thin 4本糸 4 Threads	一般地縫用 (薄・中厚) Thin Medium 4本糸 4 Threads	一般地縫用 (中厚・厚) Medium Thick 4本糸 4 Threads	極厚物用 Extra Heavy 4本糸 4 Threads		ラフラー用 Ruffling 4本糸 4 Threads
サブクラス Sub-Class S=Standard H=High-Lift E=Extra High-Lift	4010-22-S2F -23-S2F -24-S2F -25-S2F	4020-33-S3F -34-S3F -35-S3F -36-H3F -37-H3F	4030-54-S3F -55-S3F -56-H3F -57-H3F	4050-35-E2W	4050-55-E3W -56-E3W	4420-25-S3F
針巾 (mm) Needle Gauge	2	3	5	3	5	2
1 針 (個数) Needle (Qty)	151474-011 (2)	151474-014 (2)	151474-016 (2)	151474-018 (2)		151474-014 (2)
2 押工組 Presser Foot Assy (押工 F Presser Foot .F)	S19304-101 (S19312-001) 	S19313-201 (S30971-001) 	S19317-101 (S19312-001) 	S25557-001 (S19340-001) 	S19334-001 (S19340-001) 	S25548-101 (S19325-001) 
3 針止め組 Needle Clamp Assy	S29146-001 	S20404-001 	S20406-001 	S29631-001 	S21104-001 	S29146-001 
4 針板 Needle Plate	S25194-001 (2) S25195-001 (3) S19174-001 (4) S19175-001 (5) 	S20235-001 (4) S20236-001 (5) S35651-001 (6) S25196-001 (7) 	S20231-001 (4) S20232-001 (5) S20233-001 (6) S25197-001 (7) 	S25200-001 (3) S25201-001 (5) 	S19185-001 (5) S19186-001 (6) S19187-001 (7) 	S25198-001 (4) S25199-001 (5) 
5 主送り歯組 Main Feed Dog Assy (主送り歯 Main Feed Dog) (補助送り歯 Chain Feed Dog)	S19221-201 (S19222-201) (S33172-001) L 	S20241-101 (S20242-101) (S20243-101) H 	S20239-101 (S20240-101) (S19223-101) F 	S19228-101 (S19229-001) (S19223-101) F 	S19224-201 (S19225-201) (S33172-001) L 	
6 差動送り歯 Differential Feed Dog	S19245-001 	S20244-001 	S25566-001 	S19247-001 	S19246-001 	
7 上メス Upper Knife 角メス Angle Knife	上メス Upper knife 144074-350 		角メス Angle knife S20898-101 		上メス Upper knife 144074-350 	
8 下メス Lower Knife	(2) S20899-001 (T=1.0) (3, 4, 5) S20582-001 (T=1.5) 	(3) S20899-001 (T=1.0) (4, 5, 6, 7) S20582-001 (T=1.5)	S20582-001 (T=1.5)	S20583-001 (T=1.5) 		S20582-001 (T=1.5)
9 上ルーパ Over Looper	S20421-001 L 	S20423-001 (4, 5) M S20421-001 (6, 7) L	S20423-001 (3, 4, 5) M S20421-001 (6, 7) L	S20429-001 Q		S20423-001 M



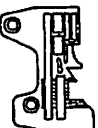
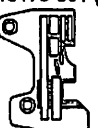
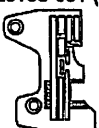
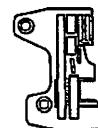
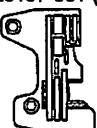
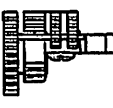
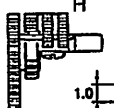
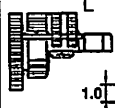
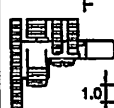
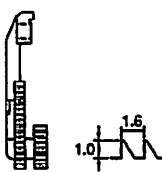
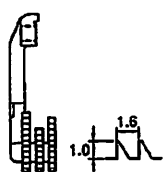





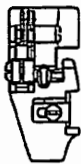
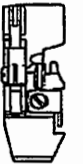
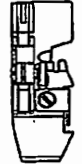
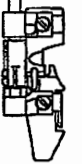

Ga2 . ゲージ部品一覧表 / Gauge parts List

用途 Application	ラフラー Ruffling 4本糸 4 Threads		テープ用 Taping 4本糸 4 Threads		パイピングラフラー用 Ruffling W / Piping 4本糸 4 Threads	
	サブクラス Sub-Class S=Standard H=High-Lift E=Extra High-Lift	4420-35-S3F	4430-55-S3F	4520-35-S3F	4530-54-S3F -55-S3F	4620-35-H3F
針巾 (mm) Needle Gauge	3	5	3	5	3	5
1 針 (個数) Needle (Qty)	151474-014 (2)		151474-014 (2)	151474-016 (2)	151474-014 (2)	
2 押工組 Presser Foot Assy (押工 F Presser Foot .F)	S19321-101 (S19325-001) 	S19326-101 (S19325-001) 	S19330-201 (S30971-001) 	S20882-201 (S30971-001) 	S25550-001 (S25553-001) 	
針止め組 Needle Clamp Assy	S20404-001 	S20406-001 	S20404-001 	S20406-001 	S20404-001 	S20406-001 
4 針板 Needle Plate	S19497-001 (4) S19182-001 (5) 	S19183-001 (5) S19184-001 (6) 	S20235-001 (4) S20236-001 (5) 	S20231-001 (4) S20232-001 (5) S20233-001 (6) 	S19182-001 (5) 	S19183-001 (5) S19184-001 (6) 
5 主送り歯組 Main Feed Dog Assy (主送り歯 Main Feed Dog) (補助送り歯 Chain Feed Dog)	S19224-201 (S19225-201) (S33172-001) L 	S19226-101 (5) (S19227-101) (S19223-101) F S19224-201 (6) (S19225-201) (S33172-101) L 	S20241-101 (S20242-101) (S20243-101) H 	S20239-101 (S20240-101) (S19223-101) F 	S19224-201 (S19225-201) (S33172-001) L 	S19226-101 (5) (S19227-101) (S19223-101) F S19224-201 (6) (S19225-201) (S33172-001) L L 
6 差動送り歯 Differential Feed Dog	S19246-001 	S20245-001 	S20244-001 	S19246-001 		
7 上メス Upper Knife	上メス Upper knife 144074-350 					
8 下メス Lower Knife 	S20582-001 (T=1.5)					
9 上ルーバ Over Looper 	S20423-001 M			S20423-001 (4, 5) M S20421-001 (6) L		S20423-001 M

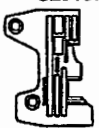
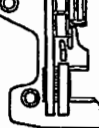
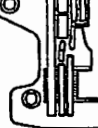
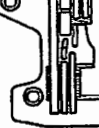
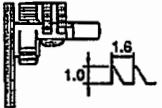

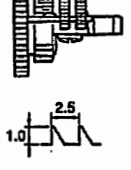
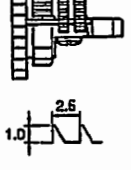
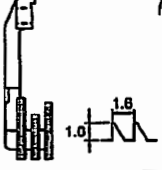
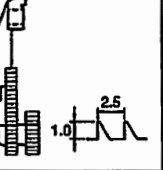
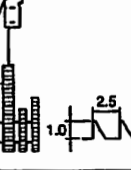
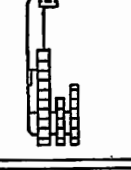







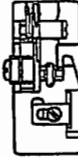
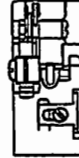

Ga3 . ゲージ部品一覧表 / Gauge parts List

用途 Application	バイディング用 Binding 4本糸 4 Threads	一般地縫用 (薄) Thin 5本糸 5 Threads	一般地縫用 (薄) Thin (小回り用) (For small type)	一般地縫用 (薄・中厚) Thin Medium 5本糸 5 Threads	一般地縫用 (薄・中厚) Thin Medium (小回り用) (For small type)	一般地縫用 (中厚・厚) Medium Thick 5本糸 5 Threads
サブクラス Sub-Class S=Standard H=High-Lift E=Extra High-Lift	4720-34-S2F -35-S2F	5010-22-S2F -23-S2F -24-S2F -25-S2F	5010-23-S2F -24-S2F -05-S2F	5020-33-S3F -34-S3F -35-S3F -36-H3F -37-H3F	5021-33-S2F -34-S2F -35-S2F	5030-54-S3F -55-S3F -56-H3F -57-H3F
針巾 (mm) Needle Gauge	3	2		3		5
1 針 (個数) Needle (Q'ty)	151474-014 (2)	151474-011 (2)		151474-014 (2)		151474-016 (2)
2 押工組 Presser Foot Assy (押工 F Presser Foot .F)	S25560-101 (S19312-001) 	S19304-101 (S19312-001) 	S30586-001 (3, 4) ツメ Stitch Tongue S30588-001 S30592-001 (5) ツメ Stitch Tongue S30593-001 	S19313-201 (S30971-001) 	S30594-001 (3, 4) ツメ Stitch Tongue S30588-001 S30597-001 (5) ツメ Stitch Tongue S30593-001 	S19317-101 (S19312-001) 
3 針止め組 Needle Clamp Assy	S20404-001 	S29146-001 		S20404-001 		S20406-001 
4 針板 Needle Plate	S25202-001 (4) S25203-001 (5) 	S25194-001 (2) S25195-001 (3) S19174-001 (4) S19175-001 (5) 		S20235-001 (4) S20236-001 (5) S35651-001 (6) S25196-001 (7) 	S19176-001 (3) S19177-001 (4) S19178-001 (5) 	S20231-001 (4) S20232-001 (5) S20233-001 (6) S25197-001 (7) 
5 主送り歯組 Main Feed Dog Assy (主送り歯 Main Feed Dog) (補助送り歯 Chain Feed Dog)	S19221-201 (S19222-201) (S33172-001) L 		S20241-101 (S20242-101) (S20243-101) H 		S19221-201 (S19222-201) (S33172-001) L 	S20239-101 (S20240-101) (S19223-101) F 
6 差動送り歯 Differential Feed Dog	S19245-001 		S20244-001 			
7 上メス Upper Knife	上メス Upper knife 144074-350 					
8 下メス Lower Knife 	S20582-001 (T=1.5)	(2) S20899-001 (T=1.0) (3, 4, 5) S20582-001 (T=1.5)		(3) S20899-001 (T=1.0) (4, 5, 6, 7) S20582-001 (T=1.5)		S20582-001 (T=1.5)
9 上ルーパ Over Looper 	S20423-001 M	S20422-001 A		S20424-001 (3,4,5) B S20428-001 (6,7) C	S20424-001 B	S20424-001 (4,5) B S20428-001 (6,7) C



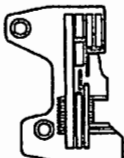
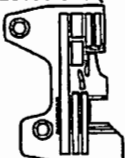
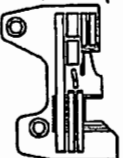
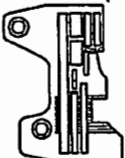
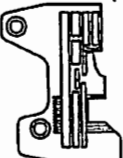
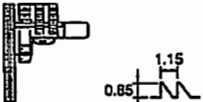
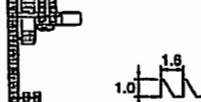
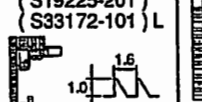
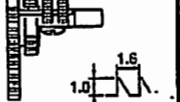
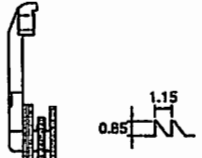
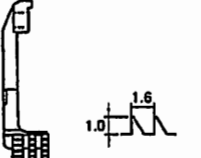
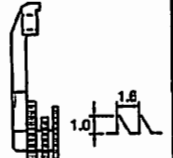







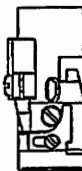

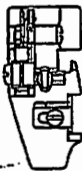
Ga4 . ゲージ部品一覧表 / Gauge parts List

用途 Application	一般地縫用 (中厚・厚) Medium Thick 5本糸 5 Threads	極厚物用 Extra Heavy 5本糸 5 Threads		極厚物用 Extra Heavy (縦ポケット用) (For Vertical Pocket)
サブクラス Sub-Class S=Standard H=High-Lift E=Extra High-Lift	5033-54-H3A -55-H3A -56-H3A -57-H3A	5050-33-E2W -35-E2W	5050-55-E3W -56-E3W -57-E3W	5051-55-E3W -56-E3W -57-E3W
針巾 (mm) Needle Gauge	5	3	5	
1 針 (個数) Needle (Q'ty)	151474-016 (2)	151474-018 (2)		
2 押工組 Presser Foot Assy (押工 F Presser Foot .F)	(S19312-001) 	S25557-001 (S19340-001) 	S19334-001 (S19340-001) 	S30525-001 (S30532-001) 
止メ組 Needle Clamp Assy	S21104-001 	S29631-001 	S21104-001 	S21104-001 
4 針板 Needle Plate	S20231-001 (4) S20232-001 (5) S20233-001 (6) S25197-001 (7) 	S25200-001 (3) S25201-001 (5) 	S19185-001 (5) S19186-001 (6) S19187-001 (7) 	S19185-001 (5) S19186-001 (6) S19187-001 (7) 
5 主送り歯組 Main Feed Dog Assy (主送り歯 Main Feed Dog) (補助送り歯 Main Feed Dog)	S35840-001 (S35991-001) (S19223-101) F 	S19228-101 (S19229-001) (S19223-101) F 	 1.0 2.5	S38595-001 (S38596-001) (S19223-101) F  1.0 2.6
6 差動送り歯 Differential Feed Dog	S35992-001 	S25566-001 	S19247-001 	オプションパーツ Option parts ウェットスーツ用 For Wet suit  1.0 2.5 S38597-001
7 上メス Upper Knife 角メス Angle Knife	角メス Angle knife S20898-101 			
8 下メス Lower Knife 	S20582-001 (T=1.5)	S20583-001 (T=1.5) 		
9 上ルーバ Over Looper 	S20428-001 C	S20438-101 G		



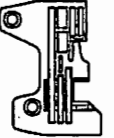
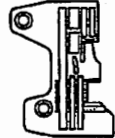
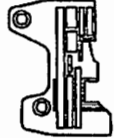
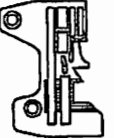
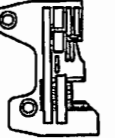
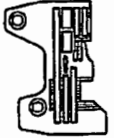
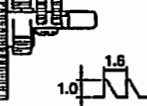
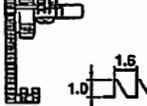
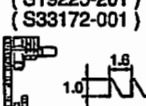
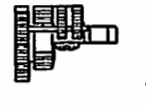
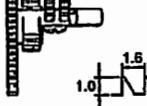
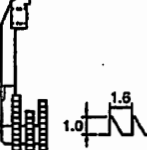
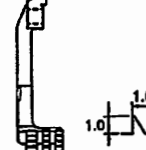
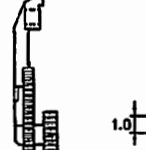
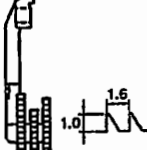

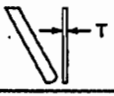

Ga5 . ゲージ部品一覧表 / Gauge parts List

用途 Application	SS用 New Synthetic Fiber	ラフラー Ruffling 5本糸 5 Threads			テープ用 Taping 5本糸 5 Threads
	50S0-35-S3F	5420-24-S3F -25-S3F	5420-34-S3F -35-S3F	5430-55-S3F -56-H3F	5520-34-S3F -35-S3F
針巾 (mm) Needle Gauge	3	2	3	5	3
1 針 (個数) Needle (Q'ty)	151474-039 (2)	151474-014 (2)			
2 押工組 Presser Foot Assy (押工 F Presser Foot .F)	S36875-001 (S19312-001) 	S25548-101 (S19325-001) 	S19321-101 (S19325-001) 	S19326-101 (S19325-001) 	S19330-201 (S30971-001) 
3 針止め組 Needle Clamp Assy	S20404-001 	S29146-001 	S20404-001 	S20406-001 	S20404-001 
4 針板 Needle Plate	S36874-001 	S25198-001 (4) S25199-001 (5) 	S19497-001 (4) S19182-001 (5) 	S19183-001 (5) S19184-001 (6) 	S20235-001 (4) S20236-001 (5) 
5 主送り歯組 Main Feed Dog Assy (主送り歯 Main Feed Dog) (補助送り歯 Chain Feed Dog)	S36871-001 (S36872-001) (S20243-101) H 	S19224-201 (S19225-201) (S33172-001) L 	S19226-101 (5) (S19227-101) (S19223-101) F S19224-201 (6) (S19225-201) (S33172-101) L 	S19241-101 (S20242-101) (S20243-101) H 	
6 差動送り歯 Differential Feed Dog	S36873-001 	S19246-001 		S20245-001 	
7 上メス Upper Knife	上メス Upper knife 144074-350 				
8 下メス Lower Knife 	S20582-001 (T=1.5)				
9 上ルーバ Over Looper 	S20424-001 B			S20424-001 (5) B S20428-001 (6) C	S20424-001 B

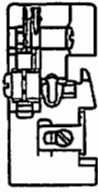

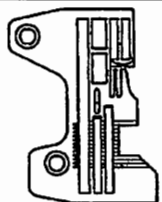
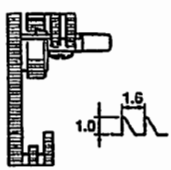
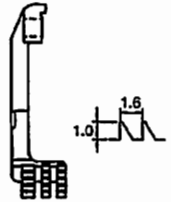
Ga6 . ゲージ部品一覧表 / Gauge parts List

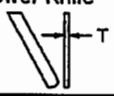
用途 Application	テープ用 Taping 5本糸 5 Threads	パイピングラフラー用 Ruffling W / Piping 5本糸 5 Threads		バイディング用 Binding 5本糸 5 Threads	3本針一般縫用 (薄・中厚) 3 Needles Thin Medium	
サブクラス Sub-Class S=Standard H=High-Lift E=Extra High-Lift	5530-54-S3F -55-S3F -56-H3F	5620-35-S3F	5630-55-S3F -56-H3F	5720-34-S2F -35-S2F	6030-B5-H2F	6030-B5-H3F
針巾 (mm) Needle Gauge	5	3	5	3	5, 2.2	
1 針 (個数) Needle (Qty)	151474-016 (2)	151474-014 (2)			151474-016 (3)	
2 押工組 Presser Foot Assy (押工 F Presser Foot .F)	S20882-201 (S30971-001) 	S25550-001 (S25553-001) 	S25555-001 	S25560-101 (S19312-001) 	S25562-101 (S19312-001) 	
針止め組 Needle Clamp Assy	S20406-001 	S20404-001 	S20406-001 	S20404-001 	S29148-001 	
4 針板 Needle Plate	S20231-001 (4) S20232-001 (5) S20233-001 (6) 	S19182-001 (5) 	S19183-001 (5) S19184-001 (6) 	S25202-001 (4) S25203-001 (5) 	S25204-001 	S31975-001 
5 主送り歯組 Main Feed Dog Assy (主送り歯 Main Feed Dog) (補助送り歯 Chain Feed Dog)	S20239-101 (S20240-101) (S19223-101) F 	S19224-201 (S19225-201) (S33172-001) L 	S19226-101 (5) (S19227-101) (S19223-101) F S19224-201 (6) (S19225-201) (S33172-001) 	S19221-201 (S19222-201) (S33172-001) L 	S20239-101 (S20240-101) (S19223-101) F 	
6 差動送り歯 Differential Feed Dog	S20244-001 	S19246-001 		S19245-001 	S20244-001 	
7 上メス Upper Knife	上メス Upper knife 144074-350 					
8 下メス Lower Knife 	S20582-001 (T=1.5)					
9 上ルーバ Over Looper 	S20424-001 (4, 5) B S20428-001 (6) C	S20424-001 B	S20424-001 (5) B S20428-001 (6) C	S20424-001 B	S20430-001 D	

Ga7 . ゲージ部品一覧表 / Gauge parts List

用途 Application	3本針 ラフラー用 3 Needles Ruffling
サブクラス Sub-Class S=Standard H=High-Lift E=Extra High-Lift	6430-B5-H3A
針巾 (mm) Needle Gauge	5 , 2.2
1 針 (個数) Needle (Q'ty)	151474-014 (3)
2 押工組 Presser Foot Assy (押工 F Presser Foot .F)	S31981-001 (S19325-001) 
3 針止メ組 Needle Clamp Assy	S29148-001 
4 針板 Needle Plate	S31979-001 
5 主送り歯組 Main Feed Dog Assy (主送り歯 Main Feed Dog) (補助送り歯 Chain Feed Dog)	S19226-101 (S19227-101) (S19223-101) F 
6 差動送り歯 Differential Feed Dog	S19246-001 
7 角メス Angle Knife	S20896-101 
8 下メス Lower Knife 	S20582-001 (T=1.5)
9 上ルーバ Over Looper 	S20430-001 D

Wa. 警告ラベル / Warning labels

警告ラベル / Warning labels	品名 / Name of parts	Size(mm)	Code
	操作注意ラベル・和	40 X 64	S38350-001
	Label, operation Eng.	40 X 64	S38349-001
	アースマーク Mark, grounding	φ 12	S37060-001

878-V6A-052

索引 / INDEX

CODE	REF.NO.	Page	CODE	REF.NO.	Page	CODE	REF.NO.	Page
S00075000	A -66	4	S19229001	Ga5 -5	51	S20240101	Ga2 -5	48
S01943001	Z -7	42		Ga6 -5	52		Ga5 -5	51
S02573000	E -38	14	S19245001	Ga1 -6	47		Ga6 -5	52
S02606000	A -3	2		Ga5 -6	51	S20241101	Ga1 -5	47
S02775001	Z -42-1-4	44		Ga6 -6	52		Ga4 -5	50
	Z -42-2-4	46	S19246001	Ga3 -6	49	S20242101	Ga1 -5	47
S02778002	Z -42-1-14	44		Ga4 -6	50		Ga4 -5	50
S02779009	Z -42-1-16	44		Ga7 -6	53	S20243101	Ga1 -5	47
	Z -42-2-15	46	S19247001	Ga6 -6	52		Ga2 -5	48
S02783001	Z -42-2-6	46	S19304101	Ga1 -2	47		Ga4 -5	50
S02786002	Z -42-1-15	44	S19307001	D -50-1-4	12	S20244001	Ga2 -6	48
S02788009	Z -42-1-17	44		D -50-6-4	12		Ga5 -6	51
	Z -42-2-16	46	S19308001	D -50-1-5	12		Ga6 -6	52
S02874001	P -1-4	32		D -50-6-5	12	S20245001	Ga1 -6	47
S04109001	Z -42-1-5	44	S19309001	D -50-1-6	12		Ga4 -6	50
	Z -42-2-5	46		D -50-6-6	12	S20305001	A -2	2
S06701000	Z -18	42	S19311101	D -50-1-1	12	S20306000	A -5	2
S06704001	Z -39	42		D -50-5-1	12	S20309101	A -11	2
	Z -39	42		D -50-6-1	12	S20310001	A -13	2
S07477009	A -84	4		D -50-10-1	12	S20311000	A -14	2
S08956100	L -8	26		D -50-15-1	12	S20313000	A -20	2
	Z -68	42	S19312001	Ga1 -2	47	S20314000	A -21	2
	Z -68	42		Ga2 -2	48	S20319001	A -27-3	2
S08957001	L -7	26		Ga5 -2	51	S20320101	A -27-5	2
S12987002	L -10	26		Ga6 -2	52	S20321001	A -27-6	2
S19174001	Ga1 -4	47	S19313201	Ga1 -2	47	S20324101	A -33	2
S19175001	Ga1 -4	47	S19317101	Ga2 -2	48	S20325001	A -35	2
S19176001	Ga1 -4	47	S19321101	Ga3 -2	49	S20327101	A -27-8	2
S19177001	Ga1 -4	47	S19325001	Ga3 -2	49	S20328001	A -37	2
S19178001	Ga1 -4	47		Ga7 -2	53	S20330100	A -39	2
S19182001	Ga3 -4	49	S19326101	Ga3 -2	49	S20331001	A -40	2
	Ga4 -4	50	S19330201	Ga4 -2	50	S20334000	A -43	2
S19183001	Ga3 -4	49	S19334001	Ga6 -2	52	S20338200	A -61	4
	Ga4 -4	50	S19340001	Ga5 -2	51	S20339000	A -62	4
S19184001	Ga3 -4	49		Ga6 -2	52	S20340001	A -69	4
	Ga4 -4	50	S19368001	D -50-16-2	12	S20342001	A -70	4
S19185001	Ga6 -4	52	S19497001	Ga3 -4	49		M -65	30
S19186001	Ga6 -4	52	S20115001	D -38-2	10	S20344009	A -74	4
S19187001	Ga6 -4	52	S20117001	D -38-3	10	S20345009	A -10	2
S19221201	Ga1 -5	47	S20118151	Z -91	42		A -75	4
	Ga5 -5	51	S20131009	R -5-6-1	38	S20346000	A -80	4
	Ga6 -5	52	S20134001	R -5-6-1-1	38	S20353000	B -21	6
S19222201	Ga1 -5	47	S20135001	R -5-6-1-2	38	S20355002	H -9-2-2	20
	Ga5 -5	51	S20158101	M -72	30	S20356001	B -11	6
	Ga6 -5	52	S20180001	L -29	26	S20361001	B -17	6
S19223101	Ga2 -5	48	S20199001	L -14	26	S20362151	B -18	6
	Ga3 -5	49		L -16	26	S20366000	B -23	6
	Ga4 -5	50		L -18	26	S20386101	C -7	8
	Ga5 -5	51	S20200001	L -30	26	S20391001	C -7-4	8
	Ga6 -5	52	S20231001	Ga2 -4	48	S20392000	C -7-5	8
	Ga7 -5	53		Ga5 -4	51		L -34	26
S19224201	Ga3 -5	49	S20232001	Ga2 -4	48	S20393101	C -8	8
	Ga4 -5	50		Ga5 -4	51	S20404001	Ga1 -3	47
S19225201	Ga3 -5	49	S20233001	Ga2 -4	48		Ga2 -3	48
	Ga4 -5	50		Ga5 -4	51		Ga3 -3	49
S19226101	Ga3 -5	49	S20234001	Ga1 -4	47		Ga4 -3	50
	Ga4 -5	50	S20235001	Ga1 -4	47		Ga5 -3	51
	Ga7 -5	53		Ga4 -4	50	S20406001	Ga2 -3	48
S19227101	Ga3 -5	49	S20236001	Ga1 -4	47		Ga3 -3	49
	Ga4 -5	50		Ga4 -4	50		Ga4 -3	50
	Ga7 -5	53	S20239101	Ga2 -5	48		Ga5 -3	51
S19228101	Ga5 -5	51		Ga5 -5	51	S20412000	A -48	2
	Ga6 -5	52		Ga6 -5	52		A -55	4

CODE	REF.NO.	Page
S20412000	Z -67	42
S20413051	C -18	8
S20414001	C -20	8
S20415101	C -22	8
S20416101	C -23	8
S20418051	C -24	8
S20421001	Ga1 -9	47
	Ga2 -9	48
	Ga5 -9	51
S20422001	Ga1 -9	47
S20423001	Ga1 -9	47
	Ga2 -9	48
	Ga3 -9	49
	Ga4 -9	50
	Ga5 -9	51
S20424001	Ga1 -9	47
	Ga2 -9	48
	Ga3 -9	49
	Ga4 -9	50
	Ga5 -9	51
S20428001	Ga1 -9	47
	Ga2 -9	48
	Ga3 -9	49
	Ga4 -9	50
	Ga5 -9	51
S20429001	Ga5 -9	51
	Ga6 -9	52
S20430001	Ga6 -9	52
	Ga7 -9	53
S20438101	Ga5 -9	51
	Ga6 -9	52
S20456000	P -1-6	32
S20459000	P -1-7	32
S20460000	P -1-8	32
	P -5-2	32
S20461101	P -5	32
S20464000	P -5-1	32
S20467001	P -5-5	32
S20468001	P -1	32
S20469000	P -1-1	32
S20470000	P -1-2	32
S20471000	P -1-3	32
S20472001	D -1	10
S20476001	D -4-1	10
S20477001	D -4-2	10
S20485001	D -19	10
S20496101	E -1	14
S20500001	E -1-2	14
S20500002	E -1-2	14
S20500003	E -1-2	14
S20507001	E -3-1	14
S20523000	E -43	14
S20524000	E -44	14
S20525001	E -45	14
S20526000	E -47	14
S20527001	E -83	16
S20530001	E -30	14
S20543101	E -51	14
S20544000	E -52	14
S20547001	E -55	16
S20548001	E -59	16
S20554001	E -58	16
S20560001	E -66	16

CODE	REF.NO.	Page
S20561001	E -67	16
S20571101	G -2	18
S20574001	G -8	18
S20577001	G -12	18
S20578101	G -13	18
S20579101	G -15-2	18
S20582001	Ga1 -8	47
	Ga2 -8	48
	Ga3 -8	49
	Ga4 -8	50
	Ga5 -8	51
	Ga6 -8	52
	Ga7 -8	53
S20583001	Ga5 -8	51
	Ga6 -8	52
S20585001	G -27	18
S20589101	G -9-1	18
S20590101	G -9-2	18
S20591101	G -17	18
S20598000	H -2	20
	J -3	22
S20601001	H -5	20
S20625151	J -11	22
S20626001	J -14-1	22
S20627001	J -14-2	22
S20640001	K -10	24
S20641001	K -11	24
S20649051	K -20	24
S20652001	K -24	24
S20653001	K -27	24
S20654001	K -29	24
S20655101	L -1	26
S20656101	L -4	26
S20657001	L -4-1	26
S20658001	L -4-3	26
S20660000	L -4-4	26
S20661000	L -4-5	26
S20662100	L -4-6	26
S20663000	L -4-7	26
S20666001	L -17	26
S20668100	L -22	26
S20669000	L -24	26
S20671000	L -28	26
S20672001	M -1	28
S20673001	M -11	28
S20675001	M -8	28
S20676051	M -9	28
	R -2-1-5	34
S20677000	M -10	28
S20678001	M -14-1	28
S20679001	M -15	28
S20681000	M -17	28
	R -2-1-7	34
S20682101	M -18-2	28
S20682102	M -18-4	28
S20682103	M -18-1	28
S20682104	M -18-3	28
S20682105	R -2-1-8	34
S20683001	M -19	28
S20684101	M -23	28
S20685001	M -25	28
S20686001	M -26	28
S20687001	M -37	28

CODE	REF.NO.	Page
S20689001	M -48	28
S20690001	M -49	28
S20691001	M -50	28
S20693001	M -5-1	28
S20694001	M -53	28
S20695001	M -55	28
S20696001	M -56	28
S20697001	M -58	28
S20698121	M -59	28
S20701001	M -66	30
S20702001	M -71	30
S20703051	M -73	30
S20707001	M -75	30
S20718000	Z -27	42
S20719000	Z -34	42
S20721001	Z -64-1	44
S20722001	Z -64-10	44
S20723001	Z -12	42
S20740101	E -46	14
S20743001	M -51	28
S20769000	Z -40	42
S20878000	A -19-	2
	A -82	4
S20882201	Ga5 -2	51
S20896101	G -15-2	18
	Ga2 -7	48
	Ga7 -7	53
S20897101	G -15-2	18
S20898101	G -15-2	18
	Ga5 -7	51
	Ga6 -7	52
S20899001	Ga1 -8	47
S21091000	E -81	16
S21092000	E -81-1	16
S21104001	Ga2 -3	48
	Ga6 -3	52
S21125001	M -44-1	28
S21126001	M -40-1	28
S21127001	M -38-1	28
S21128001	M -44-2	30
S21129001	M -40-2	30
S21130051	M -42-1	28
S21133001	M -28	28
S21134001	M -29	28
S21135001	M -31	28
S21136101	M -35	28
S21137001	M -33	28
S21293001	R -2-1	34
S21294001	R -2-1-1	34
S21295001	R -2-1-2	34
S21296001	R -2-1-9	34
S21297001	R -2-1-12	34
S21298001	R -2-1-15	34
S21299001	R -2-1-17	34
S21300001	R -2-1-19	34
S21301001	R -2-1-23	34
S21302001	R -2-1-24	34
S21303001	R -2-1-26	34
S21304001	R -2-1-28	34
S21305001	R -2-1-3	34
S21306001	R -2-1-13	34
S21307001	R -2-1-14	34
S21310001	R -6-1	34

CODE	REF.NO.	Page
S21311001	R -6-2	34
S21312001	R -6-3	34
S21313001	R -6-6	34
S21314001	R -6-7	34
S21315001	R -6-9	34
S21316001	R -6-11	34
S21318000	R -5-3	38
S21341001	Q -1-6	32
S21373101	R -3-1-1	36
S21375001	R -3-1-1-2	36
	R -3-2-1-2	36
S21376001	R -3-1-1-9	36
	R -3-2-1-9	36
S21377001	R -3-1-1-11	36
	R -3-2-1-11	36
S21378001	R -3-1-1-12	36
	R -3-2-1-12	36
S21379001	R -3-1-2	36
S21380101	R -3-2-1	36
S21381001	R -3-2-2	36
S21590000	R -2-4	34
S21798001	Z -42-1-10	44
	Z -42-2-10	46
S23337009	A -7	2
S23341009	D -31	10
S23342001	C -1-2	8
	C -7-1	8
	G -1-3	18
	H -9-1-1	20
S23346101	H -1-2	20
S23349001	R -6-13	34
S23350001	A -63	4
S23351001	A -65	4
S23353001	Z -58	42
S23356001	Z -10	42
S23357001	A -79	4
S23360001	E -37	14
	E -42	14
	K -18	24
S23364000	D -44	10
S23366001	L -3	26
S23367001	A -16	2
S23418002	C -21	8
	M -27	28
	P -2	32
	R -2-5	34
	T -6	40
S23452002	M -22	28
	M -74	30
S23453001	E -84	16
S23456101	C -25	8
	K -30	24
S23458101	E -7	14
S23460001	L -4-11	26
S23611101	H -15	20
S23612001	E -73	16
S23614101	J -12	22
	K -25	24
S23615001	E -5	14
S23616101	A -25-2	2
	E -82	16
S23619001	G -6	18
	H -6	20

CODE	REF.NO.	Page
S23621101	E -72	16
	E -76	16
	E -78	16
	G -16-1	18
S23626001	H -7	20
	J -6	22
S23628051	E -71	16
S23651002	R -2-1-18	34
	R -5-9	38
S23773001	Q -1-2	32
S23774001	R -6-8	34
S23775001	R -2-1-6	34
S23777101	R -2-1-4	34
S23779001	R -2-6	34
S23896101	Q -1-1	32
S23897001	Q -1-4	32
S24473000	Z -14	42
S25019001	R -5-8	38
S25182001	A -92	4
S25183001	A -92	4
S25184001	A -93	4
S25194001	Ga1 -4	47
S25195001	Ga1 -4	47
S25196001	Ga1 -4	47
S25197001	Ga2 -4	48
S25198001	Ga3 -4	49
S25199001	Ga3 -4	49
S25200001	Ga5 -4	51
S25201001	Ga5 -4	51
S25202001	Ga5 -4	51
S25203001	Ga5 -4	51
S25204001	Ga6 -4	52
S25526000	L -35	26
S25530001	B -1-1	6
S25548101	Ga3 -2	49
S25550001	Ga4 -2	50
S25553001	Ga4 -2	50
S25555001	Ga4 -2	50
S25557001	Ga5 -2	51
S25560101	Ga5 -2	51
S25562101	Ga6 -2	52
S25566001	Ga5 -6	51
S25818001	E -61	16
S25879001	L -32	26
S27868001	B -16	6
S29094001	E -69	16
S29102001	K -6	24
S29146001	Ga1 -3	47
	Ga3 -3	49
S29148001	Ga6 -3	52
	Ga7 -3	53
S29631001	Ga5 -3	51
S29700000	H -9-3	20
S29824000	T -4	40
S29827000	T -4	40
S29831000	T -7	40
S29835001	T -5	40
S29855109	Z -42-1	44
S29864109	Z -42-2	46
S29933000	P -5-3	32
S29934000	P -5-4	32
S30121001	M -5-2	30
S30122001	M -38-2	30

CODE	REF.NO.	Page
S30135101	R -3-1	36
S30135102	R -3-2	36
S30137011	R -6	34
S30298201	R	38
S30298202	R	38
S30298203	R	38
S30298204	R	38
S30298205	R	38
S30298206	R	38
S30299204	R	38
S30299205	R	38
S30299206	R	38
S30303001	R -5	38
S30304001	R -2	34
S30517101	A -73	4
S30525001	Ga6 -2	52
S30532001	Ga6 -2	52
S30562000	D -28	10
	E -18	14
S30586001	Ga1 -2	47
S30588001	Ga1 -2	47
S30590001	D -50-16-5	12
S30591001	D -50-16-8	12
S30592001	Ga1 -2	47
S30593001	Ga1 -2	47
S30594001	Ga1 -2	47
S30597001	Ga1 -2	47
S30888001	D -40	10
S30889001	D -38-4	10
S30890000	G -15-6	18
S30971001	Ga1 -2	47
	Ga4 -2	50
	Ga5 -2	51
S31109201	R	38
S31109202	R	38
S31109203	R	38
S31109204	R	38
S31109205	R	38
S31109206	R	38
S31110204	R	38
S31110205	R	38
S31110206	R	38
S31867001	A -92	4
S31881101	K -12	24
S31975001	Ga6 -4	52
S31979001	Ga7 -4	53
S31981001	Ga7 -2	53
S32140001	Q -1	32
S32276001	M -14-2	28
S33172001	Ga1 -5	47
	Ga3 -5	49
	Ga4 -5	50
	Ga5 -5	51
	Ga6 -5	52
S35651001	Ga1 -4	47
S35840001	Ga2 -5	48
S35991001	Ga2 -5	48
S35992001	Ga2 -6	48
S35997001	Z -29	42
	Z -64-3	44
S36007001	Z -64-4	44
S36864001	E -3-2	16
S36871001	Ga2 -5	48

CODE	REF.NO.	Page
S36872001	Ga2 -5	48
S36873001	Ga2 -6	48
S36874001	Ga2 -4	48
S36875001	Ga2 -2	48
S37037001	Z -42-1-18-3	44
	Z -42-1-19-3	44
	Z -42-1-20-3	44
	Z -42-2-17-3	46
	Z -42-2-18-3	46
	Z -42-2-19-3	46
S37038001	Z -42-1-18-2	44
	Z -42-1-19-2	44
	Z -42-2-17-2	46
	Z -42-2-18-2	46
S37060001	Wa	54
S37070121	D -34	10
S38305001	A -29-1	2
S38306051	C -26	8
S38307001	C -28	8
S38312050	E -24	14
S38320100	H -9-2-1	20
S38330050	M -46	28
S38349001	Wa	54
S38350001	Wa	54
S38595001	Ga6 -5	52
S38596001	Ga6 -5	52
S38597001	Ga6 -6	52
S38645001	Z -65	42
S38648001	Z -42-1-4-2	44
	Z -42-2-4-2	46
S39564021	A -23	2
S39565101	B -24	6
S39571021	C -10	8
S39577000	D -2-1	10
S39589021	E -8	14
S39593021	E -54	16
S39596021	E -54-1	16
S39607001	A -8	2
S39611001	A -27	2
S39612001	A -27-1	2
S39613001	A -27-2	2
S39625151	A -49	2
S39626021	A -58	4
S39629021	B -3	6
S39630000	B -10	6
S39631000	B -20	6
S39644021	C -2	8
S39645021	C -3	8
S39646021	C -4	8
S39647000	C -5	8
S39648021	C -9	8
S39649021	C -14	8
S39650051	C -16	8
S39654051	C -30	8
S39659021	D -6	10
S39660001	D -7	10
S39661001	D -8	10
S39662001	D -9	10
S39663021	D -11	10
S39664001	D -12	10
S39665001	D -15	10
S39666001	D -20	10
S39669101	D -23	10

CODE	REF.NO.	Page
S39670000	D -24	10
S39671101	D -26	10
S39672001	D -29	10
S39674001	E -9	14
S39675001	E -10	14
S39676121	E -15	14
S39677021	E -16	14
	G -5	18
	H -4	20
	J -9	22
S39678021	E -17	14
S39679001	E -20	14
S39683000	E -26	14
S39684021	E -27	14
S39685001	E -28	14
S39690021	E -36	14
	E -41	14
	K -8	24
	K -19	24
S39691001	E -39	14
S39692021	E -50	14
S39694021	E -64	16
S39695001	E -65	16
S39704021	G -4	18
S39707001	G -19	18
S39708001	G -25	18
S39709021	G -28	18
S39728021	H -3	20
	J -8	22
S39729021	K -1	24
S39732021	K -3	24
S39733001	K -4	24
S39734021	K -7	24
S39741021	K -21	24
S39742021	K -22	24
S39756021	M -63	30
S39757001	M -67	30
S39769051	E -40	14
S39770001	D -17	10
S39773001	E -35	14
S40640001	Z -42-1-7	44
	Z -42-2-7	46
S40641001	Z -42-1-18	44
	Z -42-2-17	46
S40642001	Z -42-1-19	44
	Z -42-2-18	46
S40643001	Z -42-1-20	44
	Z -42-2-19	46
S40644001	Z -42-1-21	44
	Z -42-2-20	46
S42042021	E -33	14
S42050001	A -29-2	2
S43453001	A -97	4
S43521000	L -36-2	26
S43522000	L -36-1	26
S43523000	L -36	26
S43916001	E -48	14
S44535001	A -25-3	2
S44536000	A -24	2
S44744001	D -38-1	10
S44821001	A -94	4
S44935001	K -14	24
S44937001	K -15	24

CODE	REF.NO.	Page
S44939001	K -16	24
S46849001	D -21	10
S46887001	D -2	10
S46889001	D -5	10
S46891001	E -23	14
S46895001	E -68	16
S46896001	H -9	20
S46899001	C -7-2	8
	D -22	10
	H -9-1-2	20
S46900001	B -13	6
S46901001	H -9	20
S46903001	H -13	20
S46904001	J -5	22
S46905001	L -12	26
S46907001	Z -11	42
S46921001	B -1	6
S46922001	B -1	6
S46928001	C -1	8
S46931001	C -1	8
S46932001	C -1	8
S46936001	G -1	18
S46937001	H -1	20
S46940001	H -1	20
S46943001	J -1	22
S46944001	J -1	22
004350812	E -31	14
011502012	R -6-15	34
012060632	B -25	6
	D -25	10
	E -2	14
	E -4	14
	E -73-1	16
	G -6-1	18
	H -6-1	20
	J -2	22
	R -6-4	34
012400432	A -27-4	2
	A -32	2
	A -40-1	2
	D -30	10
	E -29	14
	H -13	20
	K -5	24
	R -6-12	34
012400536	L -4-2	26
012400632	A -42	2
012400832	A -31	2
	E -32	14
012500536	L -2	26
014060632	Z -42-1-20-1	44
	Z -42-2-19-1	46
014780622	R -3-1-1-6	36
	R -3-2-1-6	36
017060812	H -8	20
	J -7	22
017061612	C -1-3-1	8
	G -1-2-1	18
017081606	R -3-1-1-8	36
	R -3-2-1-8	36
017085502	Z -64-5	44
017500812	G -26	18
017501212	A -64	4

CODE	REF.NO.	Page
017781012	R -3-1-1-4	36
	R -3-1-1-10	36
	R -3-1-1-13	36
	R -3-2-1-4	36
	R -3-2-1-10	36
	R -3-2-1-13	36
018061432	E -53	14
	H -10	20
	K -12-1	24
	K -14-1	24
	L -6	26
018061632	E -8-1	14
	E -34	14
	E -40-1	14
	E -60	16
018062532	B -28	6
	C -15	8
	D -13	10
018401032	R -2-3	34
018401622	C -1-1-1	8
	G -1-1	18
	H -1-1	20
	J -1-1	22
018401632	R -2-2	34
021060302	R -2-1-20	34
	R -2-7	34
021080106	Z -33	42
	Z -64-8	44
021400106	Z -70	42
	Z -70	42
021400202	R -3-1-3	36
	R -3-2-3	36
021400212	A -53	4
	D -18	10
	Q -1-5	32
	R -2-1-22	34
	R -6-10	34
021500106	Z -42-1-10-3	44
	Z -42-1-18-1	44
	Z -42-1-19-1	44
	Z -42-1-20-2	44
	Z -42-1-21-1	44
	Z -42-2-10-3	46
	Z -42-2-17-1	46
	Z -42-2-18-1	46
	Z -42-2-19-2	46
	Z -42-2-20-1	46
021500216	K -9	24
021500303	R -6-7-1	34
021500312	R -6-16	34
025030132	D -50-16-3	12
	G -14	18
025040132	A -45	2
	E -49	14
	G -11	18
	P -4	32
025040232	R -5-5	38
025040332	Z -60	42
025050132	A -72	4
025060332	D -14	10
025080236	Z -64-6	44
025350332	A -68	4
	E -63	16

CODE	REF.NO.	Page
025660132	D -50-10-4	12
025710232	E -12	14
	E -13	14
028050242	M -64	30
028050246	Z -42-1-10-2	44
	Z -42-2-10-2	46
028060242	B -27	6
028080242	Z -32	42
	Z -64-7	44
031411304	Z -57	42
031452206	Z -42-1-21-2	44
	Z -42-2-20-2	46
034422006	R -5-6-2	38
047161042	D -50-16-7	12
047250842	E -1-1	14
047301042	E -3-2-1	16
047301642	D -2-2	10
047401642	D -21-1	10
047502542	D -16	10
	E -57	16
047602042	A -54	4
048040342	E -14	14
	E -70	16
048090342	D -27	10
	E -19	14
048400242	B -14	6
060300412	D -35	10
	M -30	28
060300512	Z -92	42
060300612	D -39	10
	M -52	28
060350812	A -67	4
	E -62	16
	J -16	22
	K -28	24
060351012	J -15	22
060400512	A -60	4
	L -17-1	26
060400612	A -12	2
	A -27-7	2
	A -27-9	2
	A -34	2
	A -36	2
	A -46	2
	A -50	4
	A -59	4
	D -10	10
	E -22	14
	H -16	20
	M -24	28
	M -32	28
	M -36	28
	M -39	28
	M -41	28
	M -45	28
	M -54	28
	M -57	28
	M -76	30
	T -8	40
060400812	A -15	2
	A -17	2
	G -29	18
	L -11	26

CODE	REF.NO.	Page
060400812	L -26	26
	L -33	26
	M -4	28
	M -20	28
	M -43	28
	R -6-14	34
	Z -64-11	44
	Z -64-12	44
060401012	A -25-1	2
	A -47	2
	P -3	32
060401412	A -28	2
	M -68	30
060630712	E -75-1	16
061400812	A -18	2
	A -26	2
	B -6	6
	L -23	26
062060812	G -18	18
	G -21	18
062061412	Z -66	42
062300412	G -16-2	18
062300512	Q -1-7	32
062300612	K -17	24
062300812	C -29	8
	R -2-1-11	34
062350512	R -2-1-27	34
062350612	M -70	30
	Q -1-9	32
062350812	C -7-3	8
	C -27	8
	R -6-5	34
062351016	L -4-8	26
062400612	A -30	2
	C -19	8
	R -2-1-25	34
	Z -59	42
062400812	A -9	2
	B -5	6
	R -2-1-16	34
	R -5-4	38
062401012	A -22	2
	B -22	6
	C -17	8
	C -31	8
	E -6	14
	P -6	32
	Q -2	32
	R -3-1-4	36
	R -3-2-4	36
062401212	A -4	2
	A -52	4
	G -10-1	18
062401406	Z -71	42
	Z -71	42
062401612	A -81	4
	R -2-1-21	34
062402512	G -10-2	18
062501006	Z -42-1-21-3	44
	Z -42-2-20-3	46
062501406	Z -42-1-18-4	44
	Z -42-2-17-4	46
062670712	D -41	10

CODE	REF.NO.	Page
062670712	D -50-1-7	12
	D -50-5-4	12
	D -50-6-7	12
	D -50-10-6	12
	D -50-15-4	12
072600000	B -7	6
076203000	B -15	6
081005070	E -11	14
081005670	E -56	16
081008070	L -5	26
081009070	A -77	4
081020070	E -21	14
081031870	B -4	6
081044070	L -9	26
100032003	C -33	8
100080004	D -50-15-3	12
100136001	R -5-1-4	38
101118001	R -5-2	38
101572101	Z -5	42
102707002	R -2-8	34
104450101	C -11	8
105161004	D -3	10
105288001	D -50-1-3	12
	D -50-10-3	12
106640001	D -50-5-3	12
	D -50-10-5	12
108494001	R -5-1-2	38
108495001	R -5-1-3	38
110832009	M -12	28
116016001	Z -72	42
	Z -72	42
117466000	Z -13	42
118735002	C -1-3-2	8
	G -1-2-2	18
118770001	A -44	2
122991001	Z -25	42
125324001	G -11-2	18
126863001	Z -42-1-3	44
	Z -42-2-3	46
138843001	Z -42-1-12	44
	Z -42-2-12	46
140530002	D -50-6-3	12
142002001	Z -8	42
142262001	Z -24	42
142628001	E -25	14
142999101	Z -42-1-6	44
143767002	R -5-1	38
143980001	R -5-1-1	38
144074350	G -15-1	18
	Ga1 -7	47
	Ga2 -7	48
	Ga3 -7	49
	Ga4 -7	50
	Ga5 -7	51
	Ga6 -7	52
144103009	M -13	28
144225002	Z -41	42
144504001	M -60	28
144784001	R -2-1-10	34
144875001	L -4-9	26
144876001	L -4-10	26
145277205	Z -19	42
146293001	C -6	8

CODE	REF.NO.	Page
146427001	C -12-1	8
	M -47	28
146592001	M -21	28
146598001	A -71	4
	Q -1-3	32
146600001	Q -1-8	32
147893009	Z -69	42
	Z -69	42
147919051	Z -48-1	42
147919052	Z -48-2	42
147942001	L -12-1	26
148084001	L -20	26
148782001	J -13	22
	K -26	24
148797001	R -3-1-1-5	36
	R -3-2-1-5	36
148798109	R -3-1-1-7	36
	R -3-2-1-7	36
149570001	Z -9	42
150173003	Z -42-1-9	44
	Z -42-2-9	46
150174000	Z-42-1-7-1	44
	Z-42-2-7-1	46
150179002	Z-42-1-10-1	44
	Z-42-2-10-1	46
150180001	Z -42-1-1	44
	Z -42-2-1	46
150182000	Z -42-1-2	44
	Z -42-2-2	46
150185009	Z -42-1-11	44
	Z -42-2-11	46
150188009	Z -42-1-13	44
	Z -42-2-13	46
150194009	Z -42-2-14	46
150206002	Z -42-1-4-1	44
	Z -42-2-4-1	46
150307000	P -1-5	32
150755001	D -50-16-4	12
150813001	M -69	30
151474011	Ga1 -1	47
151474014	Ga1 -1	47
	Ga3 -1	49
	Ga4 -1	50
	Ga5 -1	51
	Ga7 -1	53
151474016	Ga2 -1	48
	Ga5 -1	51
	Ga6 -1	52
151474018	Ga5 -1	51
	Ga6 -1	52
151474039	Ga2 -1	48
153318201	Z -64-2	44
155162001	C -7-6	8
	H -9-1-3	20
	K -12-2	24
	K -14-2	24
155197101	R -3-1-1-1	36
	R -3-2-1-1	36
155199101	R -3-1-1-3	36
	R -3-2-1-3	36
155247000	G -3	18
	H -11	20
	J -10	22

CODE	REF.NO.	Page
155261000	K -23	24
155510001	M -62	30
155559001	B -12	6
156112003	Z -42-1-8	44
	Z -42-2-8	46
156482000	A -51	4
158722002	J -17	22
158782101	M -61	28
183797009	Z -56	42
183798001	Z -64	44
213650001	Z -31	42
	Z -64-9	44
500296002	D -50-16-6	12

brother®

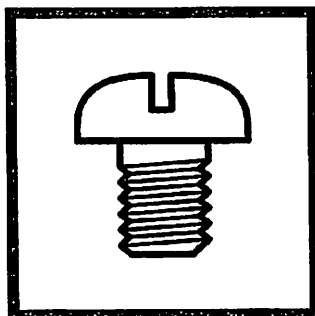

パーツブック
PARTS BOOK

ブラザー工業株式会社

〒467-8561 名古屋市瑞穂区苗代町 15 番 1 号 TEL (052) 824-2392

BROTHER INDUSTRIES, LTD

15-1, Naeshiro-cho, Mizuho-ku, Nagoya 467-8561, Japan. Phone : 81-52-824-2177

Printed in Japan

878-V6A
S97V6A-101
2002.03.C (1)